

WIRING DUCT

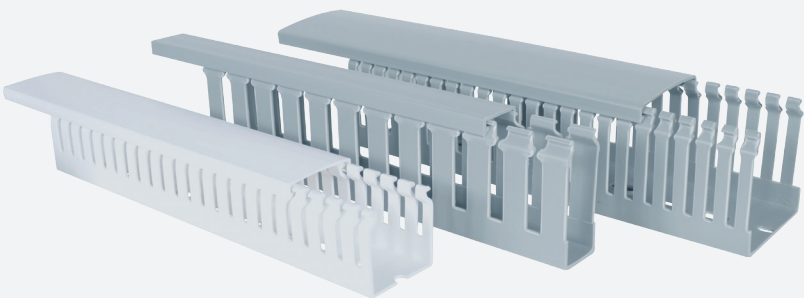

c3controls Series WD Wiring Duct and accessories optimize your wire/cable management and installation. The wide variety of types and options will increase your wiring productivity, reduce installation costs, and will give you the most attractive and organized control panels in the industry!



Narrow Slot	579
Wide Slot	580
Replacement Components	583
Accessories	584
Specifications	585
Dimensions	586
Wire Fill Capacity	588

PROVEN



Conformity to Standards:
 UL 1565
 CSA C22.2 No. 18.5-02
 IEC 61084-2-1

Certifications:
 UL File #: E330184 (Guide Z0DZ2, Z0DZ8)
 CE Marked (per EU Low Voltage Directive 2006/95/EC and
 RoHS Directive 2011/65/EU)

Visit www.c3controls.com to download product certifications.

NOTE: The scope (range, description, price, specifications, dimensions, etc.) of the product featured in this section is subject to change without notice. Refer to www.c3controls.com for product updates.

WIRING DUCT

Every product in our portfolio is designed and manufactured to meet the needs of the machine builder, including our rugged line of Wiring Duct. Check out all the features of our Series WD below!

SLEEK AND DURABLE WIRE DUCT FOR SUPERIOR PERFORMANCE IN ANY ENVIRONMENT.

✓ Proven	Our Wire Duct and covers are UL Listed and CE marked, and RoHS compliant for global acceptance. 
✓ Environmentally Secure	Non-flammable (UL94 V-0), rigid PVC won't warp, peel, chip, crack, or become brittle, and resists oil, salt solutions, and fungus for superior performance in any environment.
✓ Simple Installation	Mounting hole patterns with elongated slots comply with DIN 43659 for global installation flexibility.
✓ Vibration Resistant	Restricted slot design ensures that wires are held in place, even when the cover is not installed, allowing for durable performance in high vibration applications.
✓ Mounting Inserts Accepted	Embossed mounting holes accept mounting inserts for installing smaller wiring duct inside larger wiring duct. Mounting inserts can be installed even after the wiring duct is secured to the panel, making it easy and saving you installation time.
✓ Sleek Design	Flush side-wall and duct provide increased wire capacity and a pleasing, finished look.
✓ Easy Identification	Complete catalog number and dimensions printed on the side of the duct for quick identification and utilization.
✓ Safe Handling	Smooth, rounded edges on duct fingers and covers prevent cutting and abrasions to hands and wires.
✓ Reduced Inventory	Smaller standard package quantities, bringing you more control over your inventory.
✓ Lifetime Warranty*	Every product is backed by our lifetime warranty—unmatched in the industry—bringing you quality components that perform in the most demanding applications.
✓ Guaranteed Same-Day Shipping*	Product availability reduces inventory, and improves cash-flow—saving you money. With c3controls any order for standard catalog items received by 6:00pm ET is guaranteed to ship same-day.
✓ Advantage Pricing	Our approach to product development, manufacturing, and focus on servicing the OEM and Electrical Equipment Builder reduces cost. The result—the best value in the industry.

*See c3controls Terms & Conditions

“Like us, c3controls has great people—their customer service representatives are personable and knowledgeable, and I've always remained friends with my sales representative over the years since we began working with c3controls.”
Dave Welch, President • **Welch Engineering**

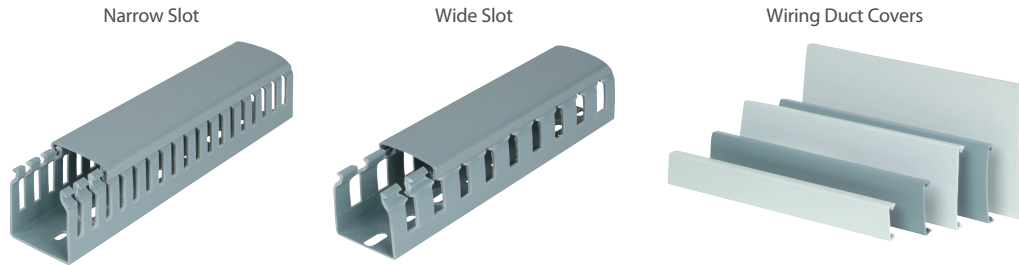

UNIQUE PRODUCT LINE FEATURES

OPTIONAL ADHESIVE BACKING



Put an end to all the eyeballing with c3controls' optional adhesive. It's an ideal convenience feature that allows you to temporarily stick your wiring duct where you want it on the panel before you permanently mount it. Just position, press, then drill and tap. Now that's convenient.

CONVENIENCE

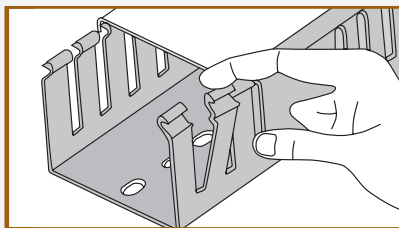

Snap-off, side wall fingers are scored to easily enlarge slots for any size wire or wire bundle. No tool is required to "snap off" fingers, and scoring ensures clean break-offs, eliminating sharp edges.

FAST WIRE ORGANIZATION

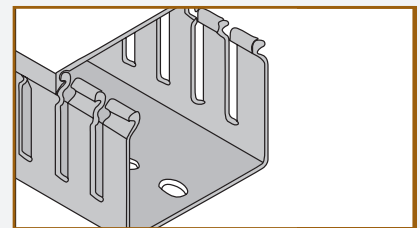

The V-shaped slot lead-in makes wire insertion fast and easy.

NON-SLIP COVER

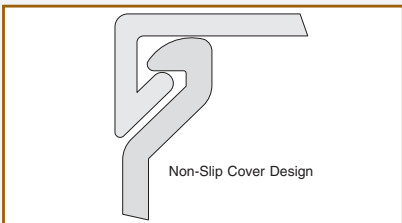

Interlocking, non-slip cover with two contact points prevents the cover from sliding, even in high vibration applications—and ensures a rigid duct assembly.

CUSTOMIZATION

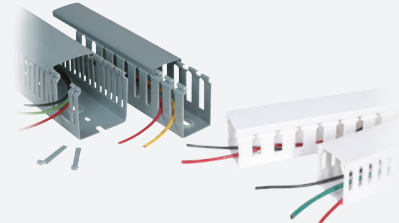

Two slot types are available to meet your capacity and flexibility needs: Narrow Slot for more precise wiring and Wide Slot for larger wires and bundles.

FIND IT FAST

Wiring Duct



- Certifications
- Specifications
- Dimension Drawings
- Installation Instructions
- Easy to Buy

www.c3controls.com

IT'S EASY TO BUILD YOUR OWN WIRING DUCT

Simply pick the code number from each of the sections below and combine them to build your part number.

Narrow (Thin) Slot Wiring Duct

WD - B **N** -

I II III IV V VI

Example: To build one of our most popular Wiring Ducts, the part number would be **WD + B + III + N + V + VI** or **WD-B40X40N**

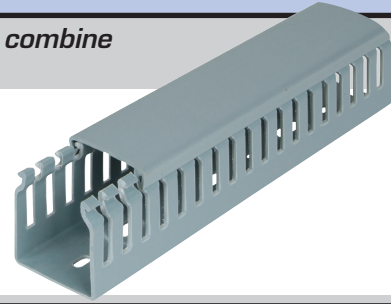

I. WIRING DUCT

CODE	DESCRIPTION
WD	Wiring Duct

II. WIRING DUCT TYPE

CODE	DESCRIPTION
B	Rigid, "U" Shaped Duct with Non-Slip Cover

III. DIMENSION

CODE	DIMENSIONS IN MM (WIDTH X HEIGHT), LENGTH: 2 METERS	DIMENSIONS IN INCHES (WIDTH X HEIGHT), LENGTH: 6'-6.75"	STANDARD PACKAGE QTY.	LIST/PC.
25X30	25 x 30	0.98 x 1.18	12	\$ 26.00
25X40	25 x 40	0.98 x 1.57	12	\$ 32.00
25X60	25 x 60	0.98 x 2.36	8	\$ 35.00
25X80	25 x 80	0.98 x 3.15	6	\$ 43.00
25X100	25 x 100	0.98 x 3.94	6	\$ 50.00
40X40	40 x 40	1.57 x 1.57	8	\$ 36.00
40X60	40 x 60	1.57 x 2.36	6	\$ 39.00
40X80	40 x 80	1.57 x 3.15	4	\$ 47.00
40X100	40 x 100	1.57 x 3.94	4	\$ 54.00
60X60	60 x 60	2.36 x 2.36	4	\$ 48.00
60X80	60 x 80	2.36 x 3.15	4	\$ 59.00
60X100	60 x 100	2.36 x 3.94	2	\$ 67.00
80X80	80 x 80	3.15 x 3.15	2	\$ 61.00

IV. SLOT TYPE

CODE	DESCRIPTION	DIMENSIONS
N	Narrow (Thin)	See Figure 1N on page 586

V. COLOR

CODE	COLOR
(Blank)	Grey
WH	White

VI. ADHESIVE BACK*

CODE	DESCRIPTION	LIST/PC.
(Blank)	No Adhesive Back	—
A	Adhesive Back for 25mm Wide	\$ 3.80
A	Adhesive Back for 40mm & 60mm Wide	\$ 7.40
A	Adhesive Back for 80mm Wide	\$ 11.00

*NOTE: Surface MUST be clean and dry—free of dirt, grease, oil, water, etc.—before applying Adhesive Backed Wiring Duct.



SOME OF OUR POPULAR CONFIGURATIONS:

WIRING DUCT—NARROW (THIN) SLOT

CATALOG NUMBER	DESCRIPTION	LIST
WD-B25X60N	Wiring Duct & Cover, W: 25mm (0.98") x H: 60mm (2.36"), Narrow (Thin) Slot, Grey	\$ 35.00
WD-B40X60N	Wiring Duct & Cover, W: 40mm (1.57") x H: 60mm (2.36"), Narrow (Thin) Slot, Grey	\$ 39.00
WD-B40X80N	Wiring Duct & Cover, W: 40mm (1.57") x H: 80mm (3.15"), Narrow (Thin) Slot, Grey	\$ 47.00
WD-B60X80N	Wiring Duct & Cover, W: 60mm (2.36") x H: 80mm (3.15"), Narrow (Thin) Slot, Grey	\$ 59.00
WD-B25X60NWH	Wiring Duct & Cover, W: 25mm (0.98") x H: 60mm (2.36"), Narrow (Thin) Slot, White	\$ 35.00
WD-B40X60NWH	Wiring Duct & Cover, W: 40mm (1.57") x H: 60mm (2.36"), Narrow (Thin) Slot, White	\$ 39.00
WD-B40X80NWH	Wiring Duct & Cover, W: 40mm (1.57") x H: 80mm (3.15"), Narrow (Thin) Slot, White	\$ 47.00
WD-B25X60N-A	Wiring Duct & Cover, W: 25mm (0.98") x H: 60mm (2.36"), Narrow (Thin) Slot, Grey w/Adhesive Backing	\$ 38.80
WD-B60X80N-A	Wiring Duct & Cover, W: 60mm (2.36") x H: 80mm (3.15"), Narrow (Thin) Slot, Grey w/Adhesive Backing	\$ 66.40

IT'S EASY TO BUILD YOUR OWN WIRING DUCT

Simply pick the code number from each of the sections below and combine them to build your part number.

Wide (Standard) Slot Wiring Duct

WD - B **W** -

I II III IV V VI

Example: To build one of our most popular Wiring Ducts, the part number would be **WD + B + III + W + V + VI** or **WD-B40X40W**



I. WIRING DUCT

CODE	DESCRIPTION
WD	Wiring Duct

II. WIRING DUCT TYPE

CODE	DESCRIPTION
B	Rigid, "U" Shaped Duct with Non-Slip Cover

III. DIMENSION

CODE	DIMENSIONS IN MM (WIDTH X HEIGHT), LENGTH: 2 METERS	DIMENSIONS IN INCHES (WIDTH X HEIGHT), LENGTH: 6'-6.75"	STANDARD PACKAGE QTY.	LIST/PC.
25X30	25 x 30	0.98 x 1.18	12	\$ 26.00
25X40	25 x 40	0.98 x 1.57	12	\$ 32.00
25X60	25 x 60	0.98 x 2.36	8	\$ 35.00
25X80	25 x 80	0.98 x 3.15	6	\$ 43.00
25X100	25 x 100	0.98 x 3.94	6	\$ 50.00
40X40	40 x 40	1.57 x 1.57	8	\$ 36.00
40X60	40 x 60	1.57 x 2.36	6	\$ 39.00
40X80	40 x 80	1.57 x 3.15	4	\$ 47.00
40X100	40 x 100	1.57 x 3.94	4	\$ 54.00
60X60	60 x 60	2.36 x 2.36	4	\$ 48.00
60X80	60 x 80	2.36 x 3.15	4	\$ 59.00
60X100	60 x 100	2.36 x 3.94	2	\$ 67.00
80X80	80 x 80	3.15 x 3.15	2	\$ 61.00

IV. SLOT TYPE

CODE	DESCRIPTION	DIMENSIONS
W	Wide (Standard)	See Figure 1W on page 586

V. COLOR

CODE	COLOR
(Blank)	Grey
WH	White

VI. ADHESIVE BACK*

CODE	DESCRIPTION	LIST/PC.
(Blank)	No Adhesive Back	—
A	Adhesive Back for 25mm Wide	\$ 3.80
A	Adhesive Back for 40mm & 60mm Wide	\$ 7.40
A	Adhesive Back for 80mm Wide	\$ 11.00

*NOTE: Surface MUST be clean and dry—free of dirt, grease, oil, water, etc.—before applying Adhesive Backed Wiring Duct.

DISCOUNT SCHEDULE **G**

SOME OF OUR POPULAR CONFIGURATIONS:

WIRING DUCT—WIDE (STANDARD) SLOT

CATALOG NUMBER	DESCRIPTION	LIST
WD-B25X60W	Wiring Duct & Cover, W: 25mm (0.98") x H: 60mm (2.36"), Wide (Standard) Slot, Grey	\$ 35.00
WD-B40X60W	Wiring Duct & Cover, W: 40mm (1.57") x H: 60mm (2.36"), Wide (Standard) Slot, Grey	\$ 39.00
WD-B40X80W	Wiring Duct & Cover, W: 40mm (1.57") x H: 80mm (3.15"), Wide (Standard) Slot, Grey	\$ 47.00
WD-B60X80W	Wiring Duct & Cover, W: 60mm (2.36") x H: 80mm (3.15"), Wide (Standard) Slot, Grey	\$ 59.00
WD-B25X60WWH	Wiring Duct & Cover, W: 25mm (0.98") x H: 60mm (2.36"), Wide (Standard) Slot, White	\$ 35.00
WD-B40X60WWH	Wiring Duct & Cover, W: 40mm (1.57") x H: 60mm (2.36"), Wide (Standard) Slot, White	\$ 39.00
WD-B40X80WWH	Wiring Duct & Cover, W: 40mm (1.57") x H: 80mm (3.15"), Wide (Standard) Slot, White	\$ 47.00
WD-B25X60W-A	Wiring Duct & Cover, W: 25mm (0.98") x H: 60mm (2.36"), Wide (Standard) Slot, Grey w/Adhesive Backing	\$ 38.80
WD-B60X80W-A	Wiring Duct & Cover, W: 60mm (2.36") x H: 80mm (3.15"), Wide (Standard) Slot, Grey w/Adhesive Backing	\$ 66.40

WIRING DUCT

c3controls Series WD Wiring Duct includes a wide variety of types, options, and accessories to simplify and optimize your wire/cable management and installation. By using all of the features of the Series WD Wiring Duct, you'll increase your wiring productivity, reduce installation costs, and end up with the most organized and attractive control panels the industry has to offer.

Wiring duct and covers are constructed of rigid, non-flammable (UL94 V-0), polyvinylchloride (PVC) and are RoHS compliant. They're also UL approved and CE marked for global compliance.

Just take a look at the Series WD Wiring Duct to see what it has to offer, and how you might realize the benefits of it in combination with our other outstanding wiring products like Series WTB2 IEC Terminal Blocks, featured on pages 430-475.

Product features include:

- cURus, CE Marked, and RoHS compliant.
- Wiring duct (and covers) are available in both grey and white to compliment your control panel design and match your company "look and feel."

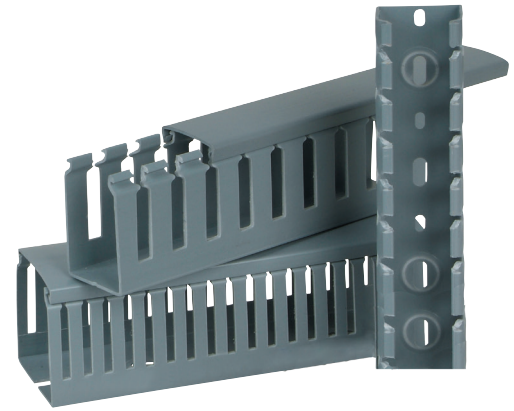

OPTIONAL ADHESIVE BACKING. CONVENIENT. ACCURATE. FAST.

We've all been there: you measure once, twice, then tap holes to mount a wire duct in your panel and discover you didn't position the holes accurately. Whether they're off by a mile or just a hair, it's a pain.

Put an end to all the eyeballing with c3controls' optional adhesive. It's an ideal convenience feature that allows you to *temporarily* stick your wiring duct where you want it on the panel before you *permanently* mount it. Just position, press, *then* drill and tap. Now that's convenient.

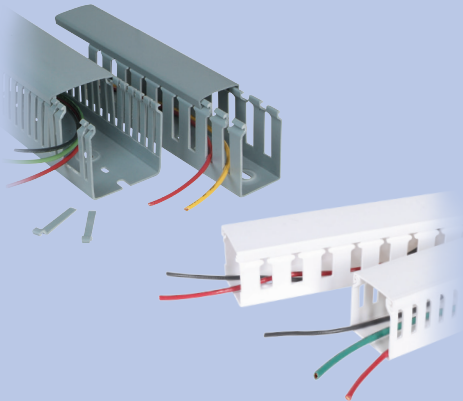

UNIQUE PRODUCT FEATURES

1. V-shaped slot lead-in makes wire insertion fast and easy.
2. Snap-off, side wall fingers are scored to easily enlarge slots for any size wire or wire bundle. Scoring ensures clean break-offs, eliminating sharp edges that can damage wire insulation and abrasions to hands. No tool is required to “snap-off” fingers.
3. Two slot types are available to meet your capacity and flexibility needs, and accept almost any size wire or wire bundle:
 - Narrow Slot** – smaller fingers for more precise wiring
 - Wide Slot** – larger slots for bigger wires and bundles
4. Interlocking, non-slip cover with two contact points prevents the cover from sliding, even in high vibration applications – and ensures a rigid duct assembly.
5. Smooth, rounded edges on duct fingers and covers prevent cutting and abrasions to hands and wires.
6. Flush side-wall and duct provide increased wire capacity and a pleasing, finished look.
7. Restricted slot design ensures that wires are held in place, even when the cover is not installed.
8. Embossed mounting holes accept mounting inserts for installing smaller wiring duct inside larger wiring duct. Mounting inserts can be installed even after the wiring duct is secured to the panel.
9. Mounting hole patterns with elongated slots comply with DIN 43659 for global installation flexibility.
10. Non-flammable (UL94 V-0), rigid PVC won't warp, peel, chip, crack, or become brittle, and resists oil, salt solutions, and fungus for superior performance in even the most demanding industrial environments.
11. Wide variety of sizes to meet your wiring capacity needs:
 - Widths from 25mm (0.98”) to 80mm (3.15”)
 - Heights from 30mm (1.18”) to 100mm (3.94”)
 - Up to 21 width/height combinations in each slot type

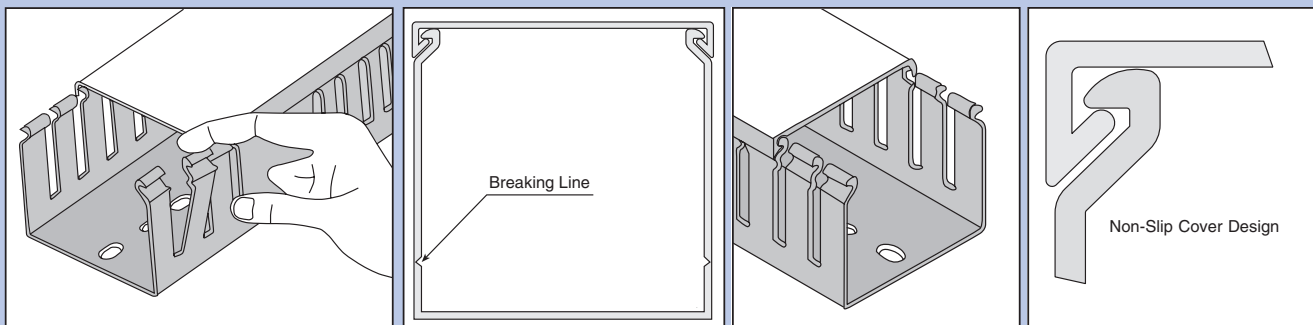

IT'S EASY TO BUILD YOUR OWN WIRING DUCT COVER

Simply pick the code number from each of the sections below and combine them to build your part number.

Wiring Duct Covers

WD - B C
 I II III IV V

Example: To build one of our most popular Wiring Duct Covers, the part number would be **WD + B + C + IV + V** or **WD-BC40WH**

NOTE: Wiring Duct Covers are provided and included as standard in the Wiring Duct catalog numbers (and list price) configured on pages 579 and 580. Separate covers should be purchased for replacement only.



I. WIRING DUCT

CODE	DESCRIPTION
WD	Wiring Duct

II. WIRING DUCT TYPE

CODE	DESCRIPTION
B	Rigid, "U" Shaped Duct with Non-Slip Cover

III. COVER

CODE	DESCRIPTION
C	Non-Slip Cover for Rigid, "U" Shaped Duct

IV. DIMENSION

CODE	DIMENSIONS IN MM (WIDTH), LENGTH: 2 METERS	DIMENSIONS IN INCHES (WIDTH), LENGTH: 6'-6.75"	FOR USE WITH DUCT DIMENSION CODES	STANDARD PACKAGE QTY.	LIST/PC.
25	25	0.98	25x30	24	\$ 8.00
			25x40		
			25x60		
			25x80		
40	40	1.57	40x40	16	\$11.00
			40x60		
			40x80		
			40x100		
60	60	2.36	60x40	12	\$12.00
			60x60		
			60x80		
			60x100		
80	80	3.15	80x80	8	\$19.00

V. COLOR

CODE	COLOR
(Blank)	Grey
WH	White



UNIVERSAL MOUNTING INSERT



Mounting Inserts are used to install smaller sizes of duct inside larger sizes of duct – for separation of electrical circuits (ex. control, power, AC, DC, etc.). Installs easily with a straight blade screwdriver. Twists into place and holds securely. Single, universal insert for all sizes of duct.

CODE	FOR USE WITH	PCS./PKG.	LIST/PC.
WD-BMTGI	All Wiring Duct Codes	100	\$0.25

UNIVERSAL CABLE TIE ATTACHMENT



Cable Tie Attachments are anchors that can be used when cable ties are used to bundle a number of wires inside the duct. Installs easily with a straight blade screwdriver. Twists into place and holds securely into the bottom of the duct. Single, universal attachment for all sizes of duct.

CODE	FOR USE WITH	PCS./PKG.	LIST/PC.
WD-BCTA1	All Wiring Duct Codes	100	\$0.60

NYLON RIVETS



Nylon Rivets are used to install wiring duct to any panel or mounting surface. Simply pushes into the duct slot.

CODE	FOR USE WITH	PCS./PKG.	LIST/PC.
WD-BNR1	6mm (1/4") Mounting Holes	100	\$0.12
WD-BNR2	4mm (5/32") Mounting Holes	100	\$0.12

WIRE RETAINERS



Wire Retainers hold wires in place inside the duct during initial wiring/ installation activities or during maintenance/alteration activities. Wire retainers prevent loose wires or wire bundles from falling out of the duct when the duct cover is removed. Simply snaps on the duct finger.

CODE	FOR USE WITH	PCS./PKG.	LIST/PC.
WD-BWRN40	WD-B40X***N Duct Codes	100	\$1.20
WD-BWRN60	WD-B60X***N Duct Codes	100	\$1.90
WD-BWRN80	WD-B80X***N Duct Codes	100	\$2.50
WD-BWRW40	WD-B40X***W Duct Codes	100	\$1.20
WD-BWRW60	WD-B60X***W Duct Codes	100	\$1.90
WD-BWRW80	WD-B80X***W Duct Codes	100	\$2.50

NOTE: *** Represents the Dimension Code. Refer to pages 579 and 580.

NAME PLATES



The Name Plate provides a simple means of identifying circuits, groups of wires, sections of control panels, or wiring for different machines. Includes a paper label and clear protective label cover. Simply snaps into the duct slot.

CODE	FOR USE WITH	PCS./PKG.	LIST/PC.
WD-BNPN1	Duct with Narrow Slots (Code N)	100	\$1.00
WD-BNPW1	Duct with Wide Slots (Code W)	100	\$1.00

MOUNTING CLIPS

Mounting Clips provide an easy method for installing wiring duct on a 35mm DIN rail. Simply snap the mounting clip on the DIN rail and secure the wiring duct to the mounting clip.



CODE	FOR USE WITH	PCS./PKG.	LIST/PC.
WD-BMC1	All Wiring Duct Codes NOTE: Wiring duct secures to the mounting clip with Nylon Rivet (BNR1).	100	\$1.90
WD-BMC2	All Wiring Duct Codes NOTE: Wiring duct secures to the mounting clip with a screw (M3, 1/8").	100	\$1.90



SPECIFICATIONS:

WIRING DUCT SPECIFICATIONS			
GENERAL	UNITS		
MATERIALS			
Wiring Duct		Rigid, Self-Extinguishing PVC	
Wiring Duct Covers		Rigid, Self-Extinguishing PVC	
Mounting Inserts		Nylon 66	
Cable Tie Attachments		Nylon 6 - Glass Filled	
Nylon Rivets		Nylon 66	
Wire Retainers		Nylon 6	
Name Plates		Nylon 6	
Mounting Clips		Nylon 6	
RoHS COMPLIANCE		For RoHS Compliance documentation by product, refer to www.c3controls.com	
CONTINUOUS USE TEMPERATURE	°F / °C	+5 to +140 / -15 to +60	
FLAMMABILITY		UL94 V-0	
STANDARD WIRING DUCT AND COVER LENGTH		2 meters (6'-6.75")	
STANDARD UNIT		Wiring Duct complete with Cover	
MATERIAL PROPERTY			
	UNITS	STANDARD	VALUE
Tensile Strength at Break	kg/cm ²	ASTM D838	>390
Tensile Modulus	kg/cm ²	ASTM D638	13,500
Flexural Strength	kg/cm ²	ASTM D790	550
Compressive Strength	kg/cm ²	ASTM D695	1190
Izod Impact Strength	kg-cm/cm	ASTM D256	7.0
Hardness - Shore D	—	ASTM D2240	75-80
HDT at 4.6 kg/cm ²	°C	ASTM D648	85
Vicat Softening Point at 5 kg Load	°C	ASTM D1525	85
Co-efficient of Linear Thermal Expansion	°C	ASTM D696	4.6 x 10 ⁻⁵
Flammability	—	UL94	V-0
Glow Wire Test (2mm)	°C	IEC 695-2-1	960
Limiting Oxygen Index	%	ASTM D2863	48.0
Specific Gravity	—	ASTM D792	1.48
Water Absorption	%	ASTM D570	0.05
Power Factor	—	ASTM D150	0.018
Dielectric Constant	—	ASTM D150	2.5
Dielectric Strength	kV/mm	ASTM D149	13
Surface Resistivity	Ohm	ASTM D257	1.29 x 10 ¹⁵
Volume Resistivity	Ohm-cm	ASTM D257	3.21 x 10 ¹⁶
Lead Content	ppm	Directive 2002/95/EC	<500
Cadmium Content	ppm	(IEC 61321)	<50

WIRING DUCT AND COVER

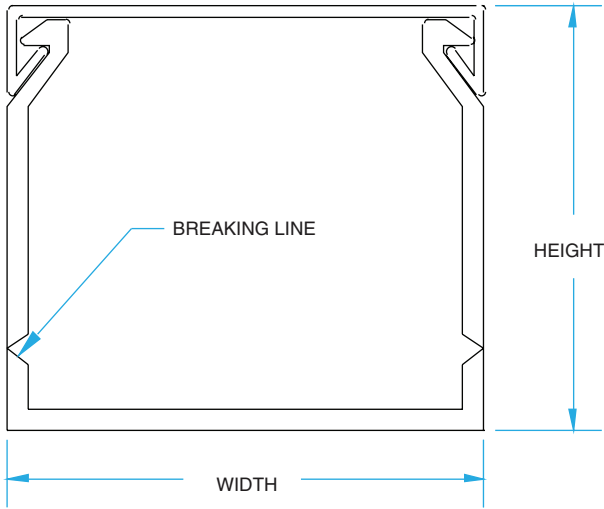

WIRING DUCT AND COVER DIMENSIONS				
DIMENSION CODE	WIDTH (MM)	HEIGHT (MM)	WIDTH (INCHES)	HEIGHT (INCHES)
25X30	25	30	0.98	1.18
25X40	25	40	0.98	1.57
25X60	25	60	0.98	2.36
25X80	25	80	0.98	3.15
25X100	25	100	0.98	3.94
40X40	40	40	1.57	1.57
40X60	40	60	1.57	2.36
40X80	40	80	1.57	3.15
40X100	40	100	1.57	3.94
60X60	60	60	2.36	2.36
60X80	60	80	2.36	3.15
60X100	60	100	2.36	3.94
80X80	80	80	3.15	3.15

SLOTS

FIGURE 1N
NARROW (THIN) SLOT

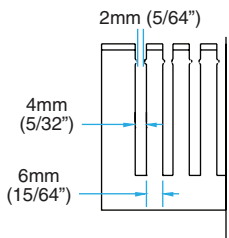
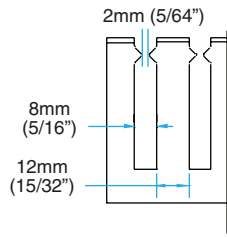
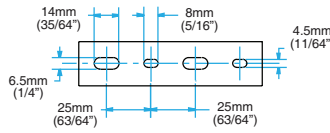

FIGURE 1W
WIDE (STANDARD) SLOT



MOUNTING PATTERNS

DUCT WIDTH: 25mm



DUCT WIDTH: 40mm and 60mm

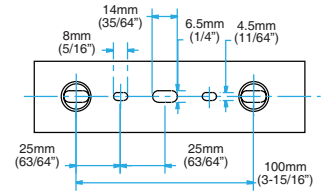

DUCT WIDTH: 80mm

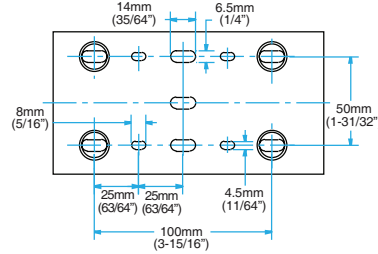

NYLON RIVETS

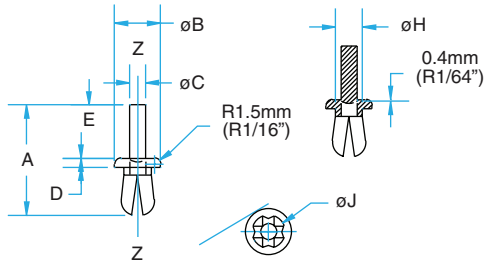

DIMENSIONS IN TABLE SHOWN ARE MM (IN)

TYPE	A	øB	øC	D	E	øH	øJ
WD-BNR1	27 (1.06)	11.2 (0.44)	3.9 (0.16)	2.2 (0.09)	13 (0.51)	6.6 (0.26)	9 (0.35)
WD-BNR2	21.4 (0.84)	9 (0.35)	2.6 (0.10)	2.2 (0.09)	10.5 (0.41)	4.8 (0.19)	6.2 (0.24)

MOUNTING CLIPS

WD-BMC1

(WIRING DUCT SECURES TO THE MOUNTING CLIP WITH NYLON RIVET CAT. No. WD-BNR1)

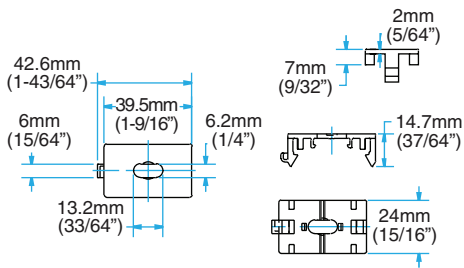

WD-BMC2

(WIRING DUCT SECURES TO THE MOUNTING CLIP WITH A SCREW [M3, 1/8"])

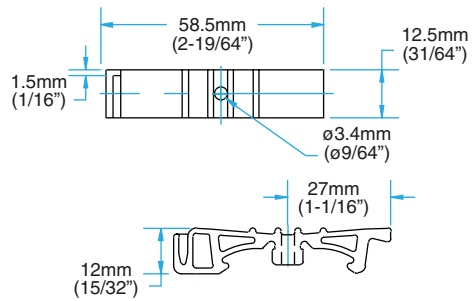

**VISIT WWW.C3CONTROLS.COM
TO DOWNLOAD CAD DRAWINGS**

Formula for calculating Fill Capacity: $Number\ of\ wires = \frac{Duct\ W\ x\ H}{1.75\ x\ (Wire\ O.D.)^2} / 2$

Note: Wire fill is based on 50% fill of duct area.

WIRING DUCT

WIRE FILL CAPACITY FOR ELECTRICAL CONDUCTORS

DIMENSION CODE	NOMINAL DUCT SIZE			NOMINAL DUCT SIZE			ELECTRICAL CONDUCTORS												
	WIDTH (MM)	HEIGHT (MM)	AREA (MM ²)	WIDTH (IN.)	HEIGHT (IN.)	AREA (IN ²)	22 AWG		18 AWG		16 AWG		14 AWG			12 AWG		10 AWG	8 AWG
							0.065	0.113	0.084	0.125	0.096	0.165	0.139	0.105	0.158	0.122	0.153	0.216	
MTW	MTW	THHN	MTW	THHN	MTW	THHN	MTW	THHN	MTW	THHN	MTW	THHN	MTW	THHN	THHN	THHN			
25X30	25	30	750	0.98	1.18	1.16	78	26	47	21	36	12	17	30	13	22	14	7	
25X40	25	40	1,000	0.98	1.57	1.54	104	34	62	28	48	16	23	40	18	30	19	9	
25X60	25	60	1,500	0.98	2.36	2.31	156	52	94	42	72	24	34	60	26	44	28	14	
25X80	25	80	2,000	0.98	3.15	3.09	209	69	125	57	96	32	46	80	35	59	38	19	
25X100	25	100	2,500	0.98	3.94	3.86	261	86	156	71	120	41	57	100	44	74	47	24	
40X40	40	40	1,600	1.57	1.57	2.46	166	55	100	45	76	26	36	64	28	47	30	15	
40X60	40	60	2,400	1.57	2.36	3.71	251	83	150	68	115	39	55	96	42	71	45	23	
40X80	40	80	3,200	1.57	3.15	4.95	335	111	200	91	153	52	73	128	57	95	60	30	
40X100	40	100	4,000	1.57	3.94	6.19	419	139	251	113	192	65	92	160	71	119	76	38	
60X60	60	60	3,600	2.36	2.36	5.57	377	125	226	102	173	58	82	144	64	107	68	34	
60X80	60	80	4,800	2.36	3.15	7.43	502	166	301	136	230	78	110	193	85	143	91	46	
60X100	60	100	6,000	2.36	3.94	9.30	629	208	377	170	288	98	138	241	106	179	114	57	
80X80	80	80	6,400	3.15	3.15	9.92	671	222	402	181	308	104	147	257	114	190	121	61	

WIRE FILL CAPACITY FOR DATA CABLE

DIMENSION CODE	NOMINAL DUCT SIZE			NOMINAL DUCT SIZE			DATA CABLE		
	WIDTH (MM)	HEIGHT (MM)	AREA (MM ²)	WIDTH (IN.)	HEIGHT (IN.)	AREA (IN ²)	24 AWG		
							0.217	0.25	0.422
UPM/CM CAT5E	CAT6	UTP/CM							
25X30	25	30	750	0.98	1.18	1.16	7	5	2
25X40	25	40	1,000	0.98	1.57	1.54	9	7	2
25X60	25	60	1,500	0.98	2.36	2.31	14	11	4
25X80	25	80	2,000	0.98	3.15	3.09	19	14	5
25X100	25	100	2,500	0.98	3.94	3.86	23	18	6
40X40	40	40	1,600	1.57	1.57	2.46	15	11	4
40X60	40	60	2,400	1.57	2.36	3.71	23	17	6
40X80	40	80	3,200	1.57	3.15	4.95	30	23	8
40X100	40	100	4,000	1.57	3.94	6.19	38	28	10
60X60	60	60	3,600	2.36	2.36	5.57	34	25	9
60X80	60	80	4,800	2.36	3.15	7.43	45	34	12
60X100	60	100	6,000	2.36	3.94	9.30	56	43	15
80X80	80	80	6,400	3.15	3.15	9.92	60	45	16

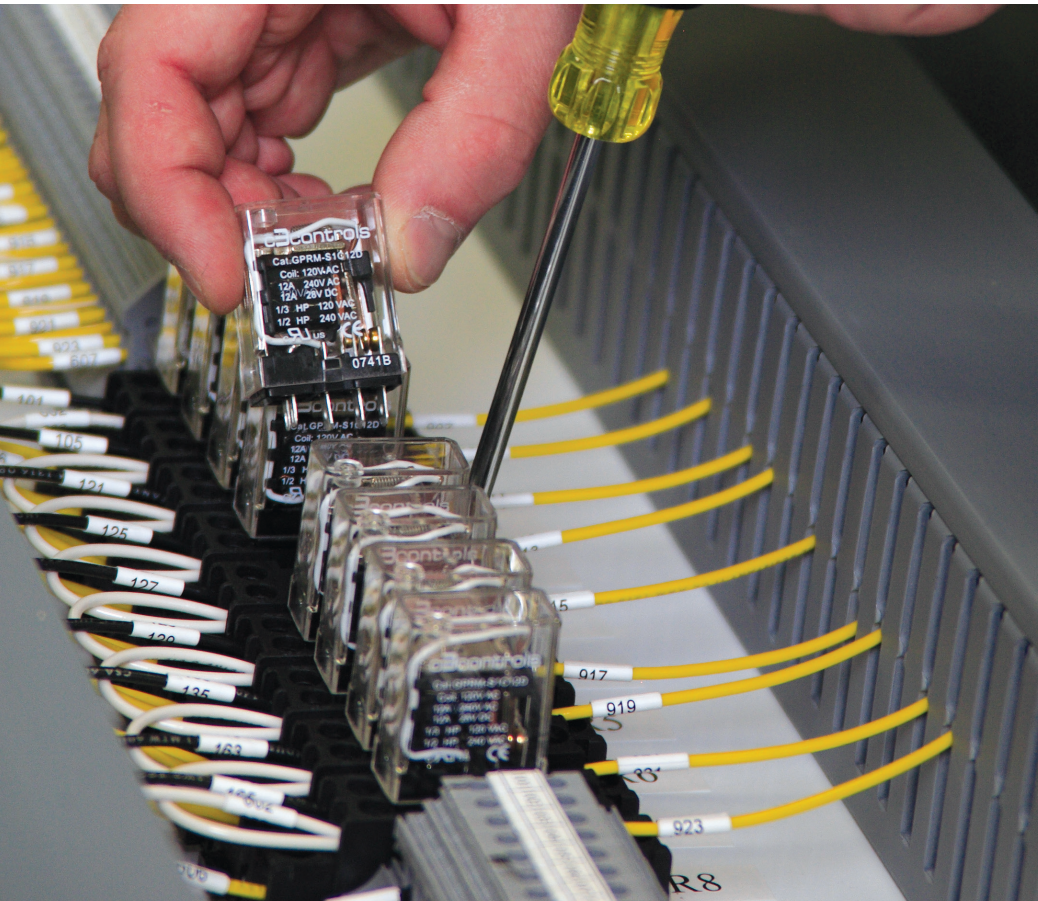

EVERYTHING UNDER CONTROL.

THIS IS WHAT YOU EXPECT, AND IT'S WHAT WE DELIVER.

Competitive pricing, superior quality, and immediate availability.

Quality products that perform to the highest standards, supported by an unmatched lifetime warranty.

Direct-from-the-manufacturer pricing that eliminates the middleman, guaranteed same-day shipping, and an unwavering commitment to your satisfaction—it's an unbeatable combination.

www.c3controls.com

c3controls[®]
Everything under control.

