

POWERS™ CONTROLS

Free Energy Band® TH 193 HC Heating/Cooling Room Thermostat

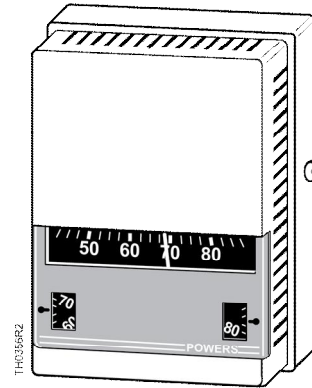

Description

The TH 193 HC thermostats are proportional, dual output, dual setpoint, two-pipe (dual one-pipe, low air capacity) or three-pipe (dual two-pipe, high air capacity) sensor controllers. Each thermostat includes a wall mounting plate for installation in a variety of rough-in terminal boxes. Sensitive bimetals respond to temperature changes to modulate control air through a flapper nozzle. As the heating load decreases due to internal heat gains, a dead band of control minimizes energy consumption while the setpoint changes from 72°F (22°C) heating mode to 78°F (26°C) cooling mode. Two setpoint dials allow adjustment of the dead band 4°F (2°C) minimum. Air connections are made with 5/32-inch (4 mm) O.D. plastic tubing, directly to the thermostat chassis for retrofit applications or with plug-in adapters (provided with the TH 192 rough-in terminal box or optional accessories), which slide into the wall mounting plate.

Features

- Direct and reverse acting for heating and cooling modes.
- Two separate, adjustable temperature setpoint indicating dials.
- Two highly sensitive bimetal thermostatic elements.
- Fahrenheit or Celsius models.
- Individual field adjustable sensitivity with graduated scale.
- Integral field adjustable limit stops.
- Control pressure test port accessible without removing cover.
- Easily replaceable thermometer, setpoint dials, filters and restrictor plate.
- Covers available for concealed or exposed thermometers, and for concealed adjustment and setpoint indication.
- Standard plastic thermostat covers provide Desert Beige or white finish.

Optional Design Features

- Fixed temperature limit stops meet government specifications.
- Metal covers available in standard configurations with Desert Beige finish.
- Competitor adapter mounting kits available.

Application

TH 193 HC thermostats control space temperature and take advantage of the dead band to "float" room temperature between heating and cooling modes while maintaining energy management (maximum economy) and occupancy comfort. TH 193 HC thermostats control valve and damper actuators in building applications that require early morning heat and afternoon cooling.

Use TH 193 HC two-pipe (dual one-pipe) thermostats with external restrictors (20 scim, 5.4 ml/sec) where a limited air capacity operates a single valve and/or actuator. Use TH 193 HC three-pipe (dual two-pipe) thermostats where multiple valves and actuators, used with or without high/low limiting controls, require higher air capacities. The thermostats are available with covers that conceal or expose the setpoint adjustment dials.

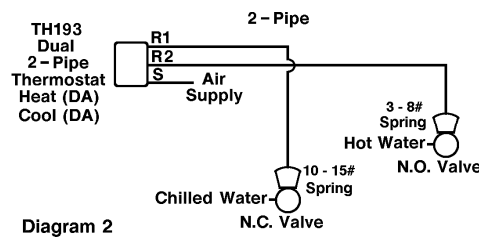
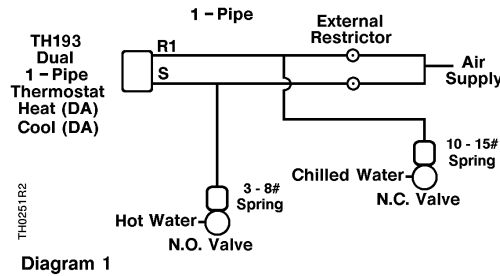

Figure 1. Typical TH 193 HC Thermostat Application.

Piping

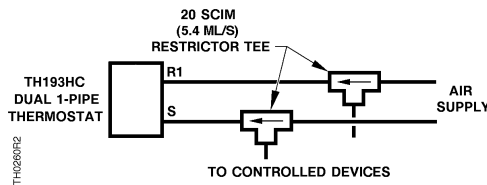

Figure 2. TH 193 HC Thermostat Dual One-Pipe Connections.

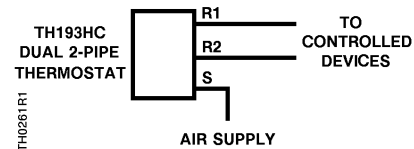

Figure 3. TH 193 HC Thermostat Dual Two-Pipe Connections.

Product Numbers and Ordering Information

See Table 1 for product number and ordering information on TH 193 HC thermostat chassis.

Chassis

1. Does the application require a one-pipe or two-pipe connection?
 - a. One-pipe thermostats are low air capacity devices and have only one port connection (R1). This application requires an external restrictor.
 - b. Two-pipe thermostats are high air capacity devices for controlling two or more terminal devices such as damper actuators or valves. This application requires two port connections: supply (S) and return (R1).
2. Is a Fahrenheit or Celsius scale required?
3. Is the heating control direct or reverse acting?
4. Is the cooling control direct or reverse acting?

Table 1. TH 193 HC Thermostat Chassis Part Numbers.

Chassis with Wall Plate					
Connection Type	Setpoint Adjustment	Fahrenheit		Celsius	
		Heating DA	Heating RA	Heating DA	Heating RA
One-Pipe Relay	Exposed at bottom of cover	Cooling DA 193-211	Cooling DA 193-213	Cooling DA 193-231	Cooling DA 193-233
		Cooling RA 193-212	—	Cooling RA 193-232	Cooling RA 193-234
Two-Pipe Relay		Cooling DA 193-215	Cooling DA 193-217	Cooling DA 193-235	Cooling DA 193-237
		Cooling RA 193-216	Cooling RA 193-218	Cooling RA 193-236	Cooling RA 193-238

Covers

See Table 2 for product number and ordering information on TH 193 HC thermostat covers.

1. Is the setpoint adjustment exposed for customer adjustment or concealed to prevent alteration of setting?
2. Is the thermometer exposed or concealed?
3. Is the setpoint indication exposed or concealed behind cover?
4. Is a plastic or zinc cast metal cover required?
 - a. Plastic covers order 192-2XX.
 - b. Metal covers order 192-3XX.
5. Is finish of cover standard or optional? The standard finish color for plastic and metal covers is Desert Beige.
 - For white plastic cover option, add "W" suffix code to cover part number (for example: 192-256W). See Table 2.

Table 2. TH 193 HC Thermostat Cover Part Numbers.

Setpoint Adjustment	Cover Configuration		Cover Part Number ²	
	Thermometer	Setpoint Indicator	Standard Plastic Cover Desert Beige	Optional Metal Cover Desert Beige
Concealed	Concealed	Concealed	192-256	192-356
	Exposed		192-254	192-354
Key ¹	Concealed	Exposed	192-267	192-367
	Exposed		192-268	192-368
Exposed	Concealed	Exposed	192-258	192-358
	Exposed		192-260	—

1. Key setpoint adjustment cover is required for all thermostat chassis with optional 1/2-inch setpoint adjustment knobs (for replacement only).
2. To order a plastic cover with white finish, add the "W" suffix code.

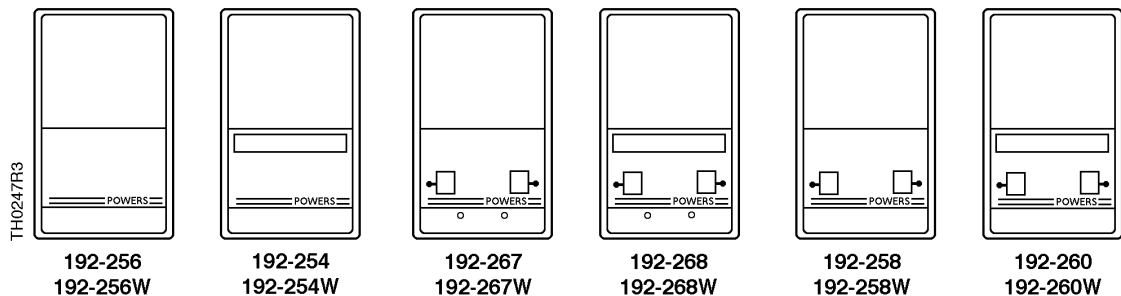

Specifications	Control action	See Table 1
	Operating ranges	45°F to 85°F (7°C to 30°C)
	Supply air pressure, maximum	30 psi (207 kPa)
	Normal air supply pressure	18 to 25 psi (124 to 172 kPa)
	Sensitivity adjustment	1 to 4 psi/°F (12 to 50 kPa/°C)
	Nominal air consumption	
	One-pipe	25 scim (6.8 ml/sec) per side
	Two-pipe	230 scim (63 ml/sec) per side
	Temperature response	0.1°F (0.06°C)
	Temperature	
	Storage temperature	-10°C to 140°F (-23°C to 60°C)
	Ambient operating temperature	40°F to 140°F (4°C to 60°C)
	Dial graduations	2°F (1°C)
	Factory settings	
	Calibration @ 72°F (22°C)	7.5 psi (52 kPa)
	Sensitivity	2.5 psi/°F (31 kPa/°C)
Limit stop adjustment	45°F and 85°F (7°C and 30°C)	
Standard cover	Cyclac, Desert Beige	
Shipping weight	0.7 lbs. (0.3 kg)	
Dimensions	See Figure 10	

Accessories

See the following Technical Bulletins for information on accessories:

Technical Bulletin	Document Number
TB 237 Terminal Kits	155-244P25
TB 214 Adapter Kits	155-231P25
TB 193 Guard Kit	155-222P25
TB 241 Test Head Kit	155-255P25
TB 167 Restrictors	155-213

Operation

The TH 193 HC thermostat is a two-temperature thermostat with two separate outputs. In direct acting control, an increase in temperature increases the control air pressure and a decrease in temperature decreases the control pressure. In reverse acting control, an increase in temperature decreases the control air pressure and a decrease in temperature increases the control pressure.

The TH 193 HC provides two separate bimetal elements; one for heating mode and the other for cooling mode. The setpoint of the two elements determines the window of the dead band. A 4°F (2°C) minimum dead band is standard, where the heating mode setpoint is 72°F (22°C) and the cooling mode setpoint is 78°F (26°C). Figure 4 shows a typical application with setpoints adjusted for a 6°F (4°C) dead band.

Figure 5 shows direct acting TH 193 HC output characteristics. As heating increases, the output pressure increases from 0 to 15 psi (0 to 103 kPa). A field adjustable dead band occurs. When the dead band elapses, cooling occurs from 0 to 15 psi (0 to 103 kPa).

**Operation,
 Continued**

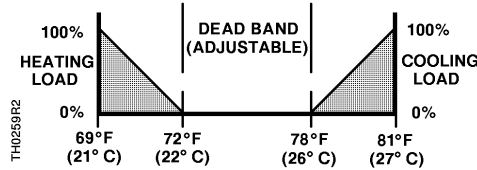

Figure 4. TH 193 HC Operating Characteristics.

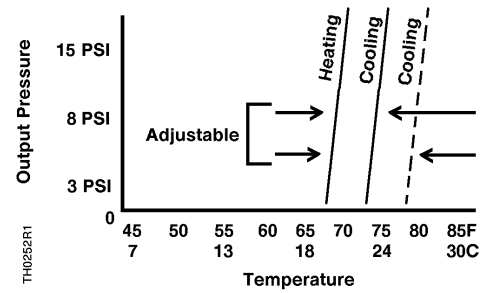

Figure 5. TH 193 HC Input/Output Characteristics.

**TH 193 HC
 Thermostat Details**

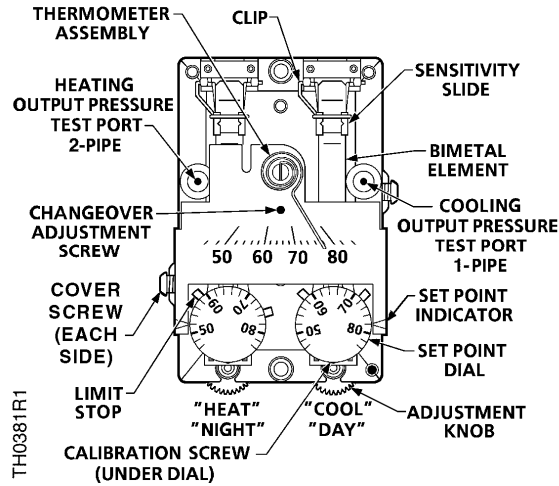

Figure 6. TH 193 HC Thermostat Details.

**Thermometer
 Calibration**

1. Use a test thermometer to read the current room temperature.
2. Place a screwdriver in the center of the thermometer assembly (Figure 6). Carefully rotate the thermometer assembly until the pointer tip indicates the correct room temperature.

NOTE: Avoid breathing on or touching the bimetal spiral since this influences the temperature reading.

Limit Stop Adjustment

Thermostat limit stops define the minimum and maximum thermostat setpoints. The limit stops engage in the setpoint cam gear teeth and cause interference between the setpoint cam gear and the adjustment knob gear.

To change limit stop settings, use needle nose pliers to pull the limit stop between the setpoint cam gear teeth. Rotate limit stop to its new position. Do not pull limit stop any more than necessary to clear the gear teeth. Changing the limit stop position one gear tooth changes the limit stop setting by 1-1/3°F (0.7°C).

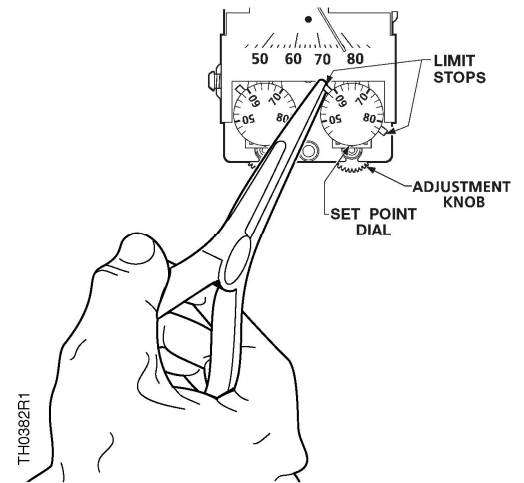

Figure 7. TH 193 HC Limit Stop Adjustments.

Sensitivity Adjustment

To change thermostat sensitivity, use a flat-blade screwdriver to carefully move the sensitivity slide to the desired position as follows:

Graduation closest to the rigid end of the bimetal element
 4 psi/°F
 (50 kPa/°C)



Graduation closest to the minimum (MIN) end of the bimetal element
 1 psi/°F
 (12 kPa/°C)

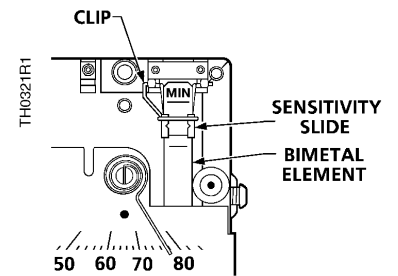

Figure 8. TH 193 HC Sensitivity Adjustment.

NOTE: If the thermostat sensitivity is adjusted, the thermostat must be recalibrated.

Thermostat Calibration

The thermostat is factory-calibrated to a control pressure of 7.5 psi (52 kPa) when the setpoint and the ambient temperature are both at 72°F (22°C). The factory sensitivity setting is approximately 2.5 psi/°F (31 kPa/°C). No adjustments are required if these settings are appropriate for the application. If the thermostat has been tampered with, the sensitivity changed, or is out of adjustment, use the following steps to recalibrate the instrument.

Cooling Calibration

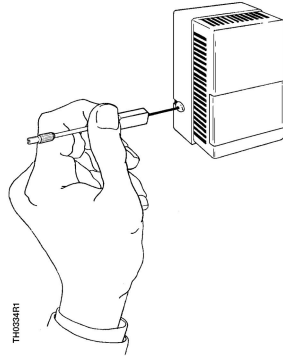

Step 1 —
Remove the cover using the 192-632 Calibration Tool. Verify that the room temperature is between 70°F and 80°F (2°C and 27°C).

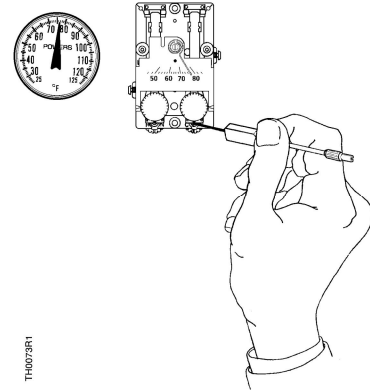

Step 2 —
Verify that the supply pressure is 18 to 25 psi (124 to 172 kPa). Set the cooling dial to room temperature by turning the exposed adjustment knob or using a hex key as shown. Allow the thermostat to stand for about five minutes to adjust to the new setting.

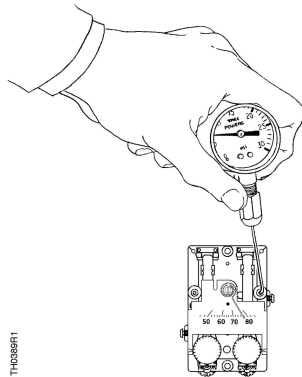

Step 3 —
Moisten the needle and insert the 192-633 Test Gauge and needle adapter in the test port. Read the control pressure.

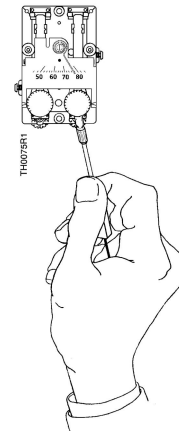

Step 4 —
If the control pressure does not read 7 to 8 psi (48 to 55 kPa), turn the calibration screw using the 192-632 Calibration Tool or a 1/8-inch (3.2 mm) wrench until the pressure is 7 to 8 psi (48 to 55 kPa). The sensing element is now in calibration and the setpoint can be changed to the desired room temperature.

Heating Calibration

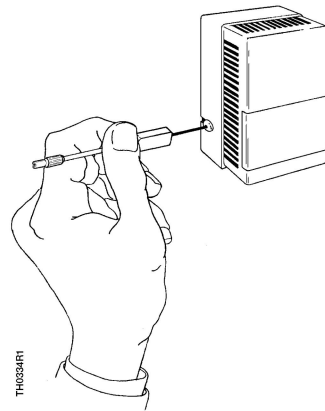

TH034R1

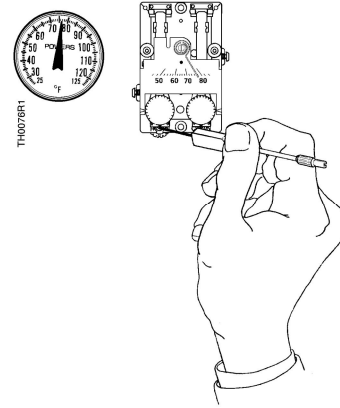

TH007R1

Step 1 —
 If not already done, remove the cover using the 192-632 Calibration Tool. Verify that the room temperature is between 70°F and 80°F (21°C and 27°C).

Step 2 —
 Verify that the supply pressure is 25 psi (172 kPa). Set the heating dial to room temperature by turning the exposed adjustment knob or using a hex key as shown. Allow the thermostat to stand for about five minutes to adjust to the new setting.

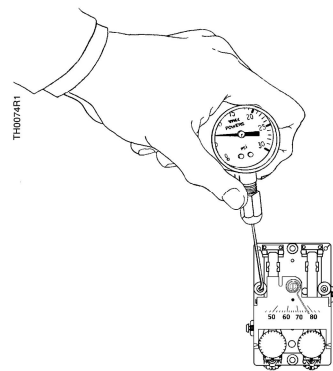

TH007R1

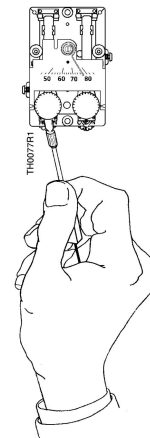

TH007R1

Step 3 —
 Moisten the needle and insert the 192-633 Test Gauge and needle adapter in the test port. Read the control pressure.

Step 4 —
 If the control pressure does not read 7 to 8 psi (48 to 55 kPa), turn the calibration screw using the 192-632 Calibration Tool or 1/8-inch (3.2 mm) wrench until pressure is 7 to 8 psi (48 to 55 kPa). The sensing element is now in calibration and the setpoint can be changed to the desired room temperature.

Troubleshooting

Before troubleshooting thermostat (see Table 4), ensure that there is clean, dry supply air at 18 psi (124 kPa) minimum. Use the test probe gauge and needle adapter to measure the control pressure at the thermostat test port.

The output pressure test port is accessible without removing the thermostat cover through the 8th opening from the top. For one-pipe thermostats, the port is on the *right* side. For two-pipe thermostats, the port is on the *left* side.

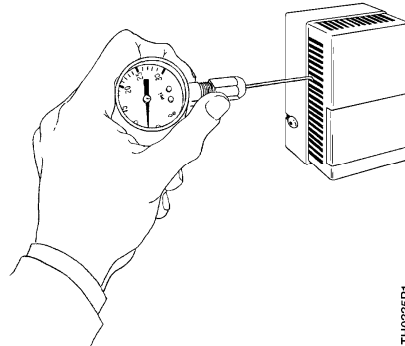

Figure 9. Accessing the Output Pressure Test Port.



CAUTION:

If you use the wrong test port, thermostat damage can occur and result in replacement of the device.

Table 3. Troubleshooting Guide.

Problem	Check	Cause	Action
Control pressure stays at approximately zero	Air supply	Low supply pressure	As required
	Nozzle or flapper	Dirt on nozzle or flapper	Clean nozzle or replace thermostat
	Restrictor	Clogged restrictor	Replace restrictor
	Calibration	Out of calibration	Recalibrate
Control pressure stays at approximately supply pressure	Nozzle	Clogged nozzle	Clean nozzle or replace thermostat
	Calibration	Dirt on either supply or exhaust valve seat	Alternately close and open nozzle by gently pushing down the bimetal
Excessive air leakage from exhaust port on left side of thermostat	Supply and return line connection	Connections are interchanged or connection to port is incorrect	As required



Chassis Tube Connector and Restrictor Plate Replacement

1. Remove the thermostat chassis from the wall. The terminal does not have a ball check valve.
NOTE: You must close off the supply air. For example, use a connector with the supply air terminal plugged.
 2. Remove the two Phillips head screws from the connector on the back of the thermostat chassis. Pull the connector out of the recess. If necessary, pry the connector loose with a screwdriver, but be careful not to damage restrictor plate and gasket.
 3. Remove the gasket from under the connector. Remove the restrictor. Remove the second gasket from under the restrictor.
 4. Use Restrictor Replacement Kit 192-321 to replace the gasket, restrictor, and second gasket.
NOTE: The restrictor plate is keyed to ensure proper orientation during installation.
 5. Remove the filters from the existing connector and insert in the new connector. Or, if the filters are dirty, use Restrictor Replacement Kit 192-321 to replace the filters.
 6. Use Chassis Tube Connector Replacement Kit 192-525 to replace the connector and mounting screws.
-

Service Parts

The following chart lists accessory parts and tools available for thermostat service.

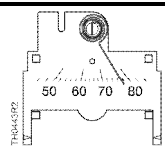
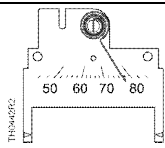
Description	Part Number
Dial thermometer (-40°F to 140°F, -40°C to 60°C) with pocket case	141-0573
Basic pneumatic calibration kit with thermometer, gauge, squeeze bulb, fittings, and case	832-177
Test head kit	832-179
Calibration tools	832-178
Test probe to check pressure with cover on	
Needle probe with 1-1/2" diameter gauge 0 to 30 psig (0 to 200 kPa) and calibration/cover wrench	192-633
Needle probe, no gauge (package of five)	192-759
1-1/2" diameter gauge, 0 to 200 kPa, back connected 1/8" NPT male	142-0344
1-1/2" diameter compound gauge, 0 to 30 psig/0 to 200 kPa, back connected 1/8" NPT male	142-0373
1-1/2" diameter compound gauge, 0 to 30 psig/0 to 200 kPa, bottom connected 1/8" NPT male.	142-0426
Replacement for use with 192-633	
Chassis tube connector replacement kit with mounting screws (material for 10 thermostats included)	192-525
Restrictor plate replacement kit with filters and gasket (material for 10 thermostats included)	192-321
Plug-in adapters for quick thermostat removal	
Straight, blue (package of 20)	192-485
Straight, white (package of 20)	192-486
Air link connects adapters for pressure tests (package of 20)	192-501
Compression ring (package of 100)	141-388
Elbow (provides quick return for wall surface mounting), blue (package of 20)	192-487
Elbow (provides quick return for wall surface mounting), white (package of 20)	192-488
20 scim (5.4 ml/sec) restrictors for one-pipe systems (package of 5). (1/4", 6.4 mm, O.D. plastic barb unless noted.)	
Brass coupling, 1/8" NPT (one only).	184-040
Coupling	184-116
Tee	184-113
Pre-piped dual tee for dual one-pipe systems	184-130

Description		Part Number	
Replacement thermometer kits, brown (packages of 5)		192-775	
Scale Range	Thermostat Model		
45°F to 85°F	 Model 3 and Up		
10°C to 30°C			
45°F to 85°F	 Models 1 and 2	192-786	
10°C to 30°C		192-785	
Replacement setpoint dials (packages of 10)			
°F, Direct Acting	Right Side		192-779
°F, Reverse Acting			192-780
°C, Direct Acting			192-783
°C, Reverse Acting			192-784
°F, Direct Acting	Left Side		192-777
°F, Reverse Acting			192-778
°C, Direct Acting			192-781
°C, Reverse Acting		192-782	

Dimensions

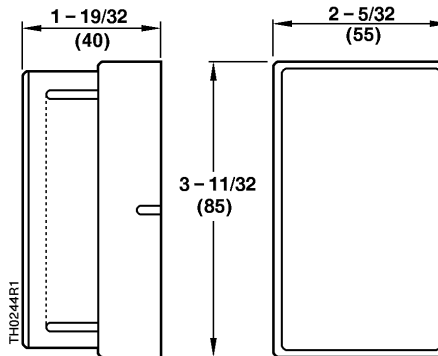

Figure 10. TH 193 HC Dimensions in Inches (Millimeters).

Information in this publication is based on current specifications. The company reserves the right to make changes in specifications and models as design improvements are introduced. POWERS and Free Energy Band are trademarks of Siemens Industry, Inc. Other product or company names mentioned herein may be the trademarks of their respective owners. © 2018 Siemens Industry, Inc.