

## POWERS™ CONTROLS

### TH 192 DN Day-Night and TH 192 DNV Day-Night-Vent Room Thermostat

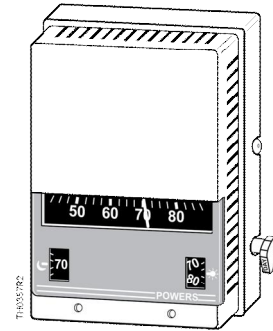

#### Description

The TH 192 DN and DNV thermostats are proportional, single output, dual setpoint, 2-pipe or 3-pipe (high air capacity) sensor controllers. Each thermostat includes a wall mounting plate for installation in a variety of rough-in terminal boxes. Sensitive bimetals respond to temperature change to modulate control air through a flapper nozzle. Two setpoint dials are provided. When the supply air pressure changes from 18 to 25 psi (124 to 172 kPa), the thermostat automatically switches from the day to the night setpoint respectively. Air connections are made with 5/32" (4 mm) O.D. plastic tubing, directly to the thermostat chassis for retrofit applications, or with plug-in adapters (provided with the TH 192 rough-in terminal box or optional accessories) which slide into the wall mounting plate.

#### Features

- Direct and reverse acting for day and night modes (DN models).
- Two separate, adjustable temperature setpoint indicating dials.
- Two highly sensitive bimetal thermostatic elements.
- Operating mode automatically switches from day to night on change of main air supply pressure.
- Manual override selector ensures off-hour occupancy comfort.
- Single screw adjustment for changeover switch setpoint.
- Individual field adjustable sensitivity with graduated scale for each mode.
- Integral field adjustable limit stops.
- Control pressure test port accessible without removing cover.
- Easily replaceable thermometer, setpoint dials, filters, and restrictor plate.
- Fahrenheit or Celsius setpoint dials.
- Covers available for concealed or exposed thermometers and for either concealed, key, or exposed knob adjustment and setpoint adjustment.
- Standard plastic thermostat covers provide Desert Beige or white finish.

## Optional Design Features

- Fixed temperature limit stops meet government specifications.
- Metal covers available in Desert Beige.
- Competitor adapter mounting kits available.
- Some thermostat chassis are available with optional, 1/2-inch, large setpoint adjustment knobs.

## Application

TH 192 DN and DNV thermostats provide day-to-night (or weekend) temperature setback to control pneumatic valve and damper actuators in heating and cooling applications (Figure 1) such as air conditioners, space heaters, unit ventilators, and air volume controllers.

The day-night thermostat is particularly useful in locations where all rooms in a zone are not vacated at the same time. Using time clocks on evenings and weekends to reset the control system to the night mode ensures optimum energy management. When a zone is operating in maximum economy mode at night, an occupant can reset an individual space to day temperature by switching a manual override. During night control, the TH 192 DNV provides a separate output signal (full air supply) which allows ventilation to occur.

TH 192 DN and DNV thermostats maintain maximum economy and occupant comfort automatically as a day progresses from the day time setpoint (65°F to 68°F [18°C to 20°C]) to the night time setpoint (55°F to 60°F [13°C to 16°C]). The thermostats are available with covers that conceal or expose the setpoint adjustment dials.

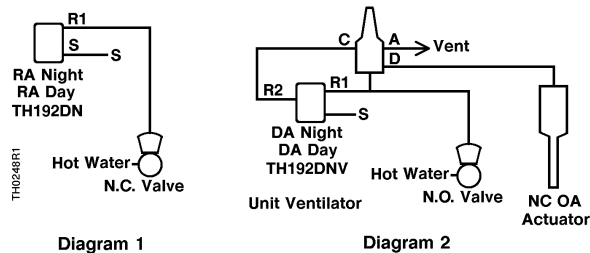
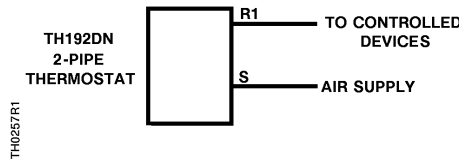

Figure 1. Typical TH 192 DN and DNV Thermostat Applications.

Table 1. Typical TH 192 DNV Thermostat Application.

Chassis Port R2 Pressure	Operation Mode (Air Supply)	Switching Relay Connection
0 Psig (0 kPa)	Day (S = 18 Psig, 124 kPa)	B - D
0 Psig (0 kPa)	Night Occupied	B - D
Full Air Supply	Night (S = 25 Psig, 172 kPa)	A - D

**Piping**



**Figure 2. TH 192 DN Thermostat Connections.**

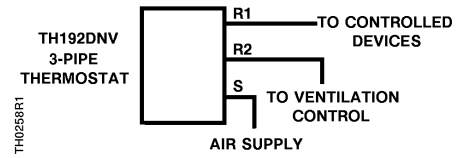

**Figure 3. TH 192 DNV Thermostat Connections.**

**Product Numbers and Ordering Information**

See Table 2 for product number and ordering information on TH 192 DN and DNV thermostat chassis.

**Chassis**

1. Is a Fahrenheit or Celsius scale required?
2. Is the day and night time control direct or reverse acting?
3. Is a separate, full supply output signal required for ventilation control?
4. Where is setpoint adjustment knob located?
  - a. Adjustment knob located at bottom of chassis.
  - b. Adjustment knob on front with 1/2-inch, large exposed knob.

**Table 2. TH 192 DN & DNV Thermostat Chassis Part Numbers.**

Chassis with Wall Plate					
Connection Type	Control Action	Fahrenheit		Celsius	
		Exposed at Bottom of Cover	Exposed 1/2" Knob on Cover *	Exposed at Bottom of Cover	Exposed 1/2" Knob on Cover *
Two- or Three-Pipe Relay	Day and Night are Direct Acting	192-204	192-204K	192-224	—
	Day and Night are Reverse Acting	192-205	—	192-225	—
	Day and Night are Direct Acting with Night Vent	192-206	—	192-226	—

\* This feature requires a key setpoint adjustment cover (or key type cover). See Table 3.

## Covers

See Table 3 for product number and ordering information on TH 192 DN and DNV thermostat covers.

1. Is the setpoint adjustment exposed for customer adjustment or concealed to prevent alteration of setting?
2. Is the thermometer exposed or concealed?
3. Is the setpoint indication exposed or concealed behind cover?
4. Is a plastic or zinc cast metal cover required?
  - a. Plastic covers order 192-2XX.
  - b. Metal covers order 192-3XX.
5. Is finish of cover standard or optional? The standard finish color for plastic and metal covers is Desert Beige.
  - For white plastic cover option, add suffix code "W" to the cover part number (for example: 192-256W). See Table 2.

**Table 3. TH 192 DN and DNV Thermostat Cover Part Numbers.**

Setpoint Adjustment	Cover Configuration		Cover Part Number (See Note 2)	
	Thermometer	Setpoint Indicator	Standard Plastic Cover	Standard Metal Cover
Concealed	Concealed	Concealed	192-262	192-362
	Exposed		192-264	192-364
Key (See Note 1)	Concealed	Exposed	192-269	192-369
	Exposed		192-270	—
Key (Night), Exposed (Day) (See Note 1)	Exposed		192-271	192-371

1. Key setpoint adjustment cover required for all thermostat chassis with optional 1/2-inch, large setpoint adjustment knobs.
2. To order a plastic cover with white finish, add suffix code "W".

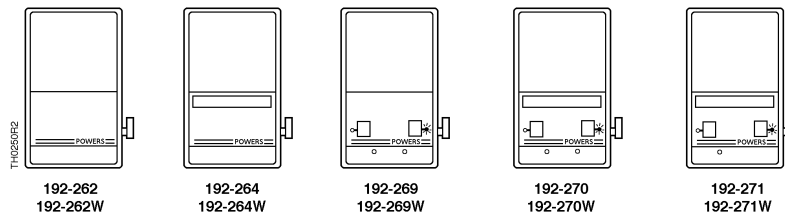

<b>Specifications</b>		
Control action		See Table 2.
Operating ranges		45 to 85°F (7 to 30°C)
Supply air pressure, maximum		30 psi (207 kPa)
Normal air supply pressure		
Day		18 psi (124 kPa)
Night		25 psi (172 kPa)
Sensitivity adjustment		1 to 4 psi/°F (12 to 50 kPa/°C)
Nominal air consumption, two-pipe		25 scim (6.8 ml/sec)
Temperature		
Storage temperature		-10 to 140°F (-23 to 60°C)
Ambient operating temperature		40 to 140°F (4 to 60°C)
Temperature response		0.1°F (0.06°C)
Dial graduations		2°F (1°C)
Factory settings		
Calibration @ 72°F (22°C)		7.5 psi (52 kPa)
Sensitivity		2.5 psi/°F (31 kPa/°C)
Limit stop adjustment		45 and 85°F (7 and 30°C)
Standard cover		Cyclac, desert beige
Shipping weight		0.7 lbs. (0.3 kg)
Dimensions		See Figure 4.

<b>Accessories</b>	See the following Technical Bulletins for information on accessories.	
	<b>Technical Bulletin</b>	<b>Document Number</b>
	TB 237 Terminal Kits	155-244
	TB 214 Adapter Kits	155-231
	TB 193 Guard Kit	155-222
	TB 241 Test Head Kit	155-255
	TB 167 Restrictors	155-213

**Dimensions**

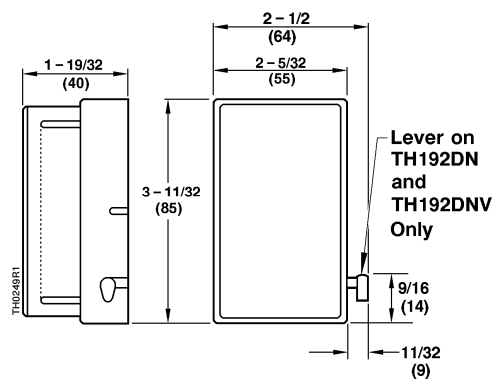

**Figure 4. TH 192 DN and DNV Dimensions in Inches (Millimeters).**

---

## Operation

### Day-Night Operation

The TH 192 DN thermostat is either direct or reverse acting for both day and night operating modes. In a direct acting thermostat, an increase in temperature increases the control air pressure, and a decrease in temperature decreases the control pressure. In a reverse acting thermostat, an increase in temperature decreases the control air pressure, and a decrease in temperature increases the control pressure.

The TH 192 DN provides two separate bimetal elements; one for day temperature and one for night temperature. Each bimetal element operates independently of the other. Use of two different supply air pressures accomplishes changeover from day to night temperature. A supply pressure of 18 psi (124 kPa) or 25 psi (172 kPa) positions a changeover switch so a changeover relay operates in the day or night mode, respectively.

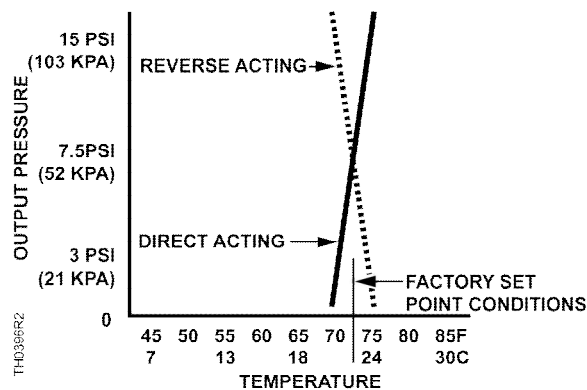

**Figure 5. TH 192 DN and DNV Input/Output Characteristics.**

---

### Manual Selector Switch

A manual selector switch allows an individual thermostat to control at its day setting even though the remainder of the system is controlling at its night setting.

- In the normal AUTO position, the manual selector switch does not interfere with air passage to the changeover relay.
- To manually set the selector switch to the DAY position, push the selector in until it latches and the handle points downward. In the latched DAY position, the manual selector switch seals off air to the changeover relay.
- To manually reset the selector switch, rotate the handle until it unlatches and returns to the normal AUTO position.
- Manual Selector Switch resets automatically when supply pressure changes back to day time control.

---

### Day-Night-Vent Operation

The TH 192 DNV provides a supplementary air line connection at the back of the thermostat.

**NOTE:** This third line feature cannot be added to a TH 192 DN in the field.

The vent line provides either 0 or 25 psi (0 or 172 kPa) pressure via the manual selector switch to pilot auxiliary controls. For example, a unit ventilator can provide continuous full day operation when the space is occupied and intermittent night operation when the space is unoccupied.

**TH 192 DN and DNV  
 Thermostat Details**

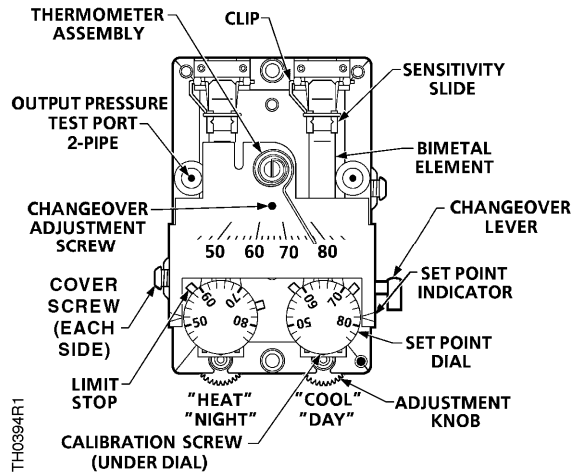

**Figure 6. TH 192 DN and DNV Thermostat Details.**

**Thermometer  
 Calibration**

1. Use a test thermometer to read the current room temperature.
2. Place a screwdriver in the center of the thermometer assembly (Figure 6). Carefully rotate thermometer assembly until the pointer tip indicates the correct room temperature.

**NOTE:** Avoid breathing on or touching the bimetal spiral since this influences the temperature reading.

**Changeover Point  
 Adjustment**

The changeover point is factory set to occur between 19 and 22 psi (131 and 152 kPa). The changeover point can be field adjustable to occur between 14 and 22 psi (96 and 152 kPa).

1. Connect a pressure gauge or manometer to measure the supply pressure to the thermostat. Use 30 psi (207 kPa) supply through a positioning switch so that pressure can be fully variable.
2. Determine the current changeover point. Turn the day dial so that day and night control pressures are different. Then, note the changeover point on the control gauge as the supply pressure changes.
3. Remove the thermometer for access to the changeover adjust screw. Use a 1/16" Allen Hex Key to adjust the changeover adjust screw as follows:
  - a. If changeover is too high, turn off the supply pressure and rotate the changeover adjust screw clockwise. One turn decreases the changeover point by about 3 psi (20 kPa). Turn on the supply pressure and recheck to verify the new changeover point.
  - b. If changeover is too low, turn off the supply pressure and rotate the changeover adjust screw counterclockwise. One turn increases the changeover point by about 3 psi (20 kPa). Turn on the supply pressure and recheck to verify the new changeover point.

## Changeover Point Adjustment, Continued

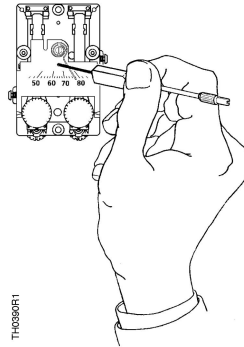

Figure 7. Changeover Point Adjustment.

## Limit Stop Adjustment

Thermostat limit stops define the minimum and maximum thermostat setpoints. The limit stops engage in the setpoint cam gear teeth and cause interference between the setpoint cam gear and the adjustment knob gear.

To change the limit stop settings, use needle nose pliers to pull the limit stop between the setpoint cam gear teeth. Rotate the limit stop to its new position. Do not pull the limit stop any more than necessary to clear the gear teeth. Changing the limit stop position one gear tooth changes the limit stop setting by 1-1/3°F (0.7°C).

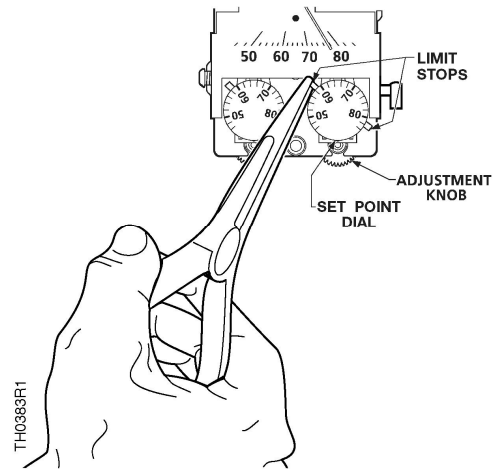

Figure 8. TH 192 DN and DNV Limit Stop Adjustments.

## Sensitivity Adjustment

To change thermostat sensitivity, use a flat-blade screwdriver to carefully move the sensitivity slide to the desired position as follows:

Graduation closest to the rigid end of the bimetal element  
 4 psi/°F  
 (50 kPa/°C)



Graduation closest to the minimum (MIN) end of the bimetal element  
 1 psi/°F  
 (12 kPa/°C)

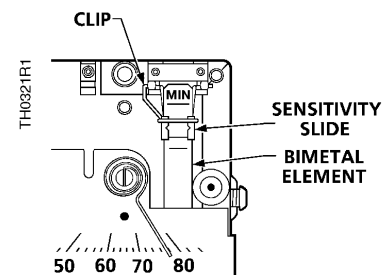

Figure 9. TH 192 DN and DNV Sensitivity Adjustment.

**NOTE:** If the thermostat sensitivity is adjusted, the thermostat must be recalibrated.



## Thermostat Calibration

The thermostat is factory calibrated to a control pressure of 7.5 psi (52 kPa) when the setpoint and the ambient temperature are both at 72°F (22°C). The factory sensitivity setting is approximately 2.5 psi/°F (31 kPa/°C). No adjustments are required if these settings are appropriate for the application. If the thermostat has been tampered with, the sensitivity has been changed, or is out of adjustment, use the following steps to re-calibrate the instrument.

### Day Time Calibration

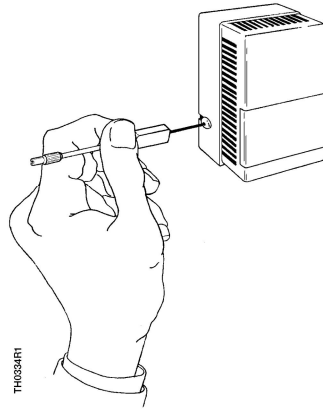

**Step 1 —**  
 Remove the cover using the 192-632 calibration tool. Verify that the room temperature is between 70 and 80°F (21 and 27°C).

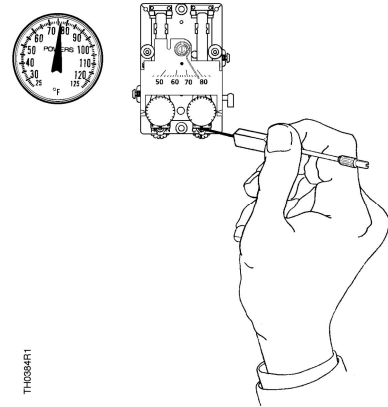

**Step 2 —**  
 Verify that the supply pressure is 18 psi (124 kPa). Set the daytime dial to room temperature by turning the exposed adjustment knob or by using a hex key as shown. Allow the thermostat to stand for about five minutes to adjust to the new setting.

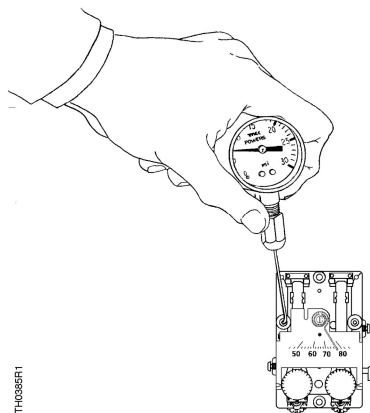

**Step 3 —**  
 Moisten the needle and insert the 192-633 test gauge and needle adapter in the test port. Read the control pressure.

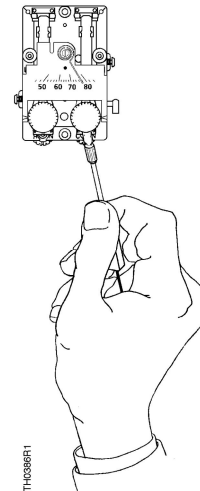

**Step 4 —**  
 If the control pressure does not read 7 to 8 psi (48 to 55 kPa), turn the calibration screw using the 192-632 calibration tool or 1/8" (3.2 mm) wrench until the pressure is 7 to 8 psi (48 to 55 kPa). The sensing element is now in calibration and the setpoint can be changed to the desired room temperature.

## Night Time Calibration

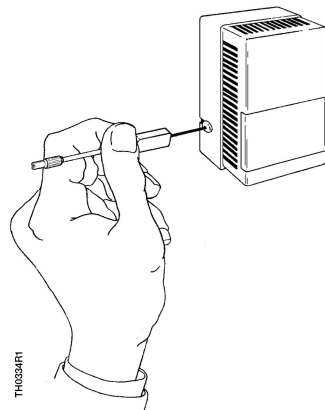

### Step 1 —

If not already done, remove the cover using the 192-632 calibration tool. Verify that the room temperature is between 70 and 80°F (21 and 27°C).

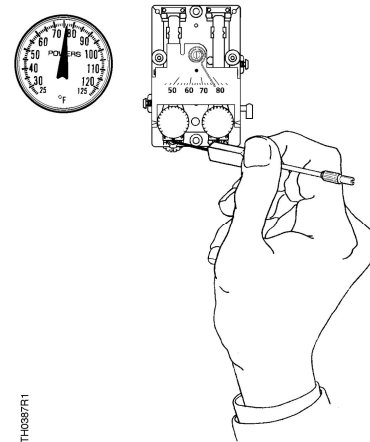

### Step 2 —

Verify that the supply pressure is 25 psi (172 kPa). Set the nighttime dial to room temperature by turning the exposed adjustment knob or using a hex key as shown. Allow the thermostat to stand for about five minutes to adjust to the new setting.

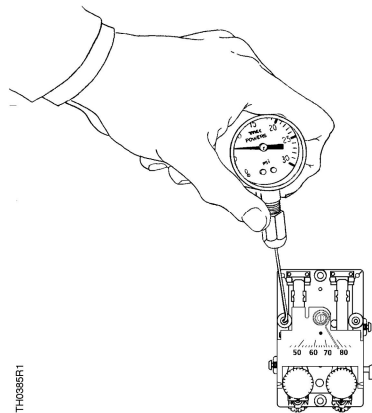

### Step 3 —

Moisten the needle and insert the 192-633 test gauge and needle adapter in the test port. Read the control pressure.

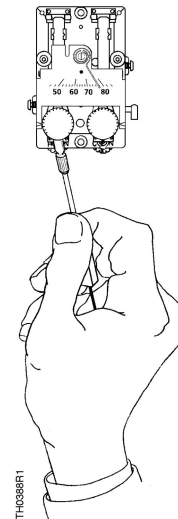

### Step 4 —

If the control pressure does not read 7 to 8 psi (48 to 55 kPa), turn the calibration screw using the 192-632 calibration tool or a 1/8" (3.2 mm) wrench until the pressure is 7 to 8 psi (48 to 55 kPa). The sensing element is now in calibration and the setpoint can be changed to the desired room temperature.

**Troubleshooting**

Before troubleshooting the thermostat per Table 5, ensure that there is clean, dry supply air at 18 psi (124 kPa) for day control, and 25 psi (172 kPa) for night. Use the test probe gauge and needle adapter to measure the control pressure at the thermostat test port.

The output pressure test port is accessible without removing the thermostat cover through the 8th opening from the top left side.

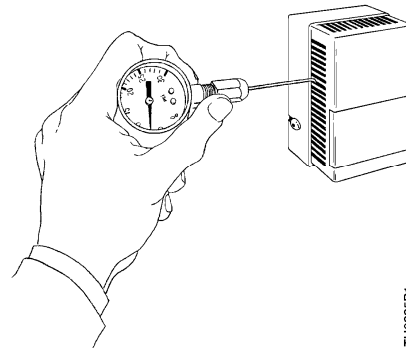

TH0335R1

**Figure 10. Accessing Output Pressure Test Port.**

**Table 4. Troubleshooting Guide.**

<b>Problem</b>	<b>Check</b>	<b>Cause</b>	<b>Action</b>
Control pressure stays at approximately zero	Air supply	Low supply pressure	As required
	Nozzle or flapper	Dirt on nozzle or flapper	Clean nozzle or replace thermostat
	Restrictor	Clogged restrictor	Replace restrictor
	Calibration	Out of calibration	Recalibrate
Control pressure stays at approximately supply pressure	Nozzle	Clogged nozzle	Clean nozzle or replace thermostat
	Calibration	Dirt on either supply or exhaust valve seat	Alternately close and open nozzle by gently pushing down the bimetal
Excessive air leakage from exhaust port on left side of thermostat	Supply and return line connection	Connections are interchanged or connection to port is incorrect	As required

## Chassis Tube Connector and Restrictor Plate Replacement



1. Remove the thermostat chassis from the wall. The terminal does not have a ball check valve.
- NOTE:** You must close off the supply air. For example, use a connector with the supply air terminal plugged.
2. Remove the two Phillips head screws from the connector on back of the thermostat chassis. Pull the connector out of the recess. If necessary, pry the connector loose with a screwdriver, but be careful not to damage the restrictor plate and gasket.
  3. Remove the gasket from under the connector. Remove the restrictor. Remove the second gasket from under the restrictor.
  4. Use Restrictor Replacement Kit 192-321 to replace the gasket, restrictor, and second gasket.
- NOTE:** The restrictor plate is keyed to ensure proper orientation during installation.
5. Remove the filters from the existing connector and insert in the new connector. Or, if filters are dirty, use Restrictor Replacement Kit 192-321 to replace filters.
  6. Use Chassis Tube Connector Replacement Kit 192-525 to replace the connector and mounting screws.

## Service Parts

The following chart lists accessory parts and tools available for thermostat service:

Description	Part Number
Dial thermometer (-40 to 140°F, -40 to 60°C) with pocket case	141-0573
Basic pneumatic calibration kit with thermometer, gauge, squeeze bulb, fittings, and case	832-177
Test head kit	832-179
Calibration tools	832-178
Test probe to check pressure with cover on	
Needle probe with 1-1/2" diameter gauge 0 to 30 psig (0 to 200 kPa) and calibration/cover wrench	192-633
Needle probe, no gauge (package of five)	192-759
1-1/2" diameter gauge, 0 to 200 kPa, back connected 1/8" NPT male	142-0344
1-1/2" diameter compound gauge, 0 to 30 psig/0 to 200 kPa, back connected 1/8" NPT male	142-0373
1-1/2" diameter compound gauge, 0 to 30 psig/0 to 200 kPa, bottom connected 1/8" NPT male.	142-0426
Replacement for use with 192-633	
Chassis tube connector replacement kit with mounting screws (material for 10 thermostats included)	192-525
Restrictor plate replacement kit with filters and gasket (material for 10 thermostats included)	192-321

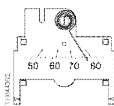
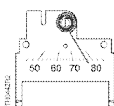
**Service Parts  
 (Continued)**

Description		Part Numbers	
Plug-in adapters for quick thermostat removal Straight, blue (package of 20) Straight, white (package of 20) Air link connects adapters for pressure tests (package of 20) Compression ring (package of 100) Elbow (provides quick return for wall surface mounting), blue (package of 20) Elbow (provides quick return for wall surface mounting), white (package of 20)		192-485 192-486 192-501 141-388 192-487 192-488	
20 scim (5.4 ml/sec) restrictors for 1-pipe systems (package of 5). (1/4", 6.4 mm, O.D. plastic barb unless noted.) Brass coupling, 1/8" NPT (1 only). Coupling Tee Pre-piped dual tee for dual 1-pipe systems		184-040 184-116 184-113 184-130	
Replacement thermometer kits, brown (package of 5)			
<b>Scale Range</b>	<b>Thermostat Model</b>		
45° to 85°F		192-775	
10° to 30°C	<b>Model 3 and Up</b>	192-776	
45° to 85°F		192-786	
10° to 30°C	<b>Models 1 and 2</b>	192-785	
Replacement setpoint dials (package of 10)			
°F, Direct Acting	Right Side		192-779
°F, Reverse Acting			192-780
°C, Direct Acting			192-783
°C, Reverse Acting			192-784
°F, Direct Acting	Left Side		192-777
°F, Reverse Acting			192-778
°C, Direct Acting			192-781
°C, Reverse Acting			192-782

Information in this publication is based on current specifications. The company reserves the right to make changes in specifications and models as design improvements are introduced. POWERS is a trademark of Siemens Industry, Inc. Other product or company names mentioned herein may be the trademarks of their respective owners. © 2018 Siemens Industry, Inc.