

# TH192 HC Heating/Cooling Room Thermostat

## Product Description

The TH192 HC thermostats are proportional single output, dual set point, 2-pipe (high air capacity) temperature controllers. Each TH192 chassis includes a wall plate for thermostat installation using a variety of rough-in installation kits.

## Prerequisites

- Review all instructions before beginning installation.
- Verify job drawings are available to reference specific job site information as needed.
- Verify rough-in installation kits (wall-box or tubing runs) are pre-installed.



## Expected Installation Time

30 Minutes

## Required Tools

- Medium flat blade screwdriver
- Needle nose pliers
- Small level
- Calibration and Cover Screw Wrench or 1/16" Allen wrench (192-632)
- Needle Probe with 1-1/2" diameter, 0 to 30 psig (0 to 200 kPa) test gauge (192-633)

## Installation Conventions

<b>WARNING</b>		Personal injury/loss of life may occur if a procedure is not performed as specified.
<b>CAUTION</b>		Equipment damage, or loss of data may occur if the user does not follow procedure as specified.

## Installation

### Overview

The TH192 HC thermostat and wall plate mount vertically to a wall using a variety of rough-in installation kits (for example, wall box kits or tubing terminal kits). The ends of the air lines from the rough-in installation kits have terminal adapters that snap into the wall plate. Terminal adapters also are available separately as orderable accessories. (Note that certain retrofit applications allow air connections directly to the thermostat chassis).

"S", "R1", and "R2" labels on both the thermostat chassis and the wall plate identify the air line connections. The thermostat plugs into the terminal adapters on the wall plate. The *Piping* section of this document shows typical connections.

Two cover screws plus latch arms on the wall plate hold the thermostat in place. The cover fits over the thermostat and the two cover screws fasten it to the wall plate.

### Procedure

The following procedure is for a typical thermostat installation and assumes the rough-in installation kit is in place. See *Figure 1*.

1. The rough-in installation kit provides a supply (blue) air line and a return air line joined by an air link. Remove the terminal adapters from the air link and snap them into the wall plate at their respective locations.
2. Using the mounting screws supplied with the thermostat chassis, install the wall plate on the wall as follows:
  - a. Guide the screws through the slotted key holes on the wall plate and partially insert them into wall.
  - b. Orient the wall plate so that it is square and level.
  - c. Tighten the mounting screws to secure the wall plate in place.
3. Moisten the thermostat supply and return ports to lubricate them. Carefully insert the thermostat ports into the terminal adapter "O" rings on the wall plate.

4. Mount the cover over the thermostat.

**NOTE:** For applications that use the 1/2-inch large set point adjustment knob, align the key hole in the cover over the shaft protruding from the thermostat when mounting the cover.

Use the hex key end of the calibration and cover screw wrench or a 1/16" Allen wrench to tighten the two screws that secure the cover in place.

5. Place the optional 1/2-inch large set point adjustment knob on the shaft protruding through the cover. Use the hex key end of the calibration and cover screw wrench or a 1/16" Allen wrench to tighten the set screw on the knob.

The installation is complete.

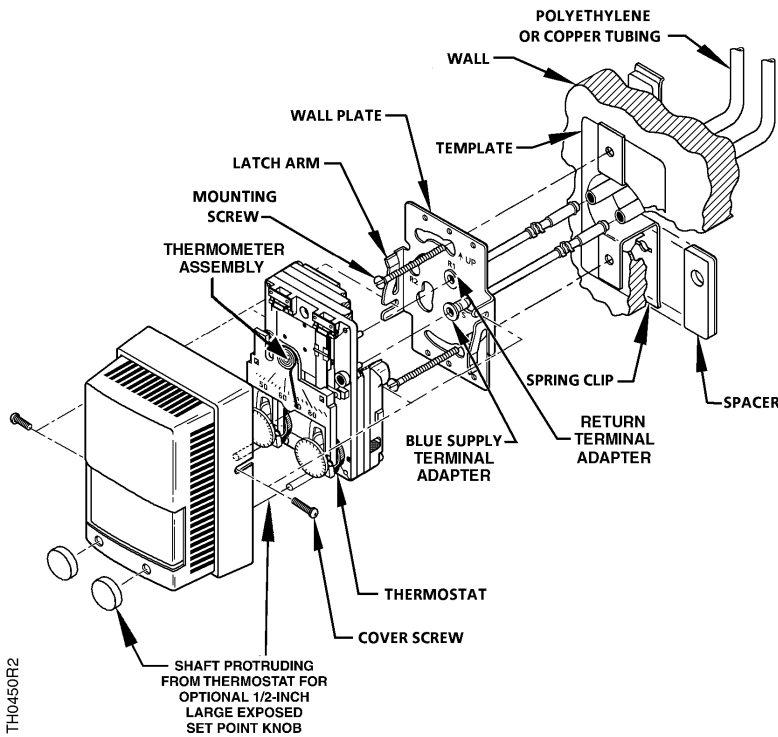

**Figure 1. Thermostat Installation (using 192-481 Tubing Terminal Kit and 182-685 Dry Wall Mounting Kit.)**

## Remodeling Installation Reference

When converting from Model TH180 or TH182 to the TH19X, you need:

- TH19X Chassis.
- A new cover. The TH180 or TH182 cover does not fit the TH19X chassis or vice versa.
- Terminal adapters. These adapters are required to retain the plug-in feature only. Otherwise, 5/32" (4 mm) tubing can connect directly to the thermostat chassis. Use compression rings (part number 141-388) to secure the connections.

When converting from competitor models to the TH19X, you need:

- TH192 Chassis.
- A new cover.
- Adapter Kit (see *TB-214, TH192 Adapter Kits Technical Bulletin*, 155-231).

## Piping

**NOTE:** All piping (see *Figure 2*) must conform to local codes and regulations and must comply with the local authority having jurisdiction.

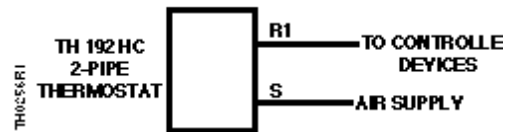

**Figure 2. TH192 HC Thermostat Connections.**

## Thermometer Calibration

1. Use a test thermometer to read the current room temperature.
2. Place a screwdriver in the center of the thermometer assembly (*Figure 3*). Carefully rotate thermometer assembly until pointer tip indicates the correct room temperature.

**NOTE:** Avoid breathing on or touching the bimetal spiral since this affects the temperature reading.

## Changeover Point Adjustment

The changeover point is factory set to occur between 19 and 22 psi (131 and 152 kPa). The changeover point can be field adjustable to occur between 14 and 22 psi (96 and 152 kPa).

1. Connect a pressure gauge or a manometer to measure the supply pressure to the thermostat. Use 30 psi (207 kPa) supply through a positioning switch so pressure can be fully variable.
2. Determine the current change over point. Turn the cooling dial so that the cooling and heating control pressures are different. Then note the changeover point on the control gauge as the supply pressure changes.
3. Place an Allen wrench in the opening of the thermometer assembly (*Figure 3*) to adjust the changeover adjustment screw as follows:
  - a. If the changeover is too high, turn off the supply pressure and rotate the changeover adjustment screw clockwise. One turn decreases the changeover point by about 3 psi (20 kPa). Turn on the supply pressure and recheck to verify the new changeover point.
  - b. If the changeover is too low, turn off the supply pressure and rotate the changeover adjustment screw counterclockwise. One turn increases the changeover point by about 3 psi (20 kPa). Turn on the supply pressure and recheck to verify the new changeover point.

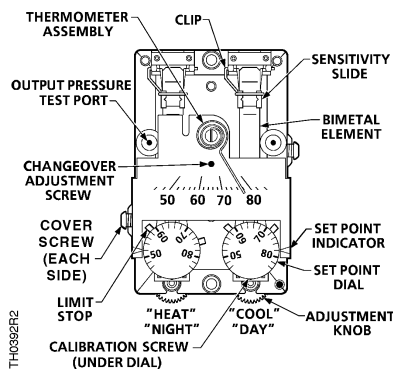

Figure 3. TH192 HC Thermostat Details.

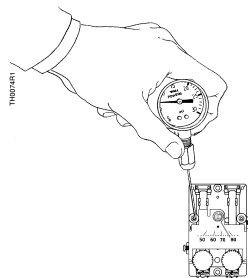

Figure 4. TH192 HC Output Pressure Test Port

## Limit Stop Adjustment

Thermostat limit stops define the minimum and maximum thermostat set points. The limit stops engage in the set point cam gear teeth and cause interference between the set point cam gear and the adjustment knob gear.

To change the limit stop settings, use a needle nose pliers to pull the limit stop (*Figure 3*) between the set point cam gear teeth. Do not pull limit stop any more than necessary to clear the gear teeth. Rotate the limit stop to its new position. Changing the limit stop position one gear tooth changes the limit stop setting by 1-1/3°F (0.7°C).

## Sensitivity Adjustment

The factory thermostat sensitivity setting is approximately 2.5 psi/°F (31 kPa/°C). To change the sensitivity, use a flat blade screwdriver to carefully move the sensitivity slide (*Figure 3*) to the desired position as follows:

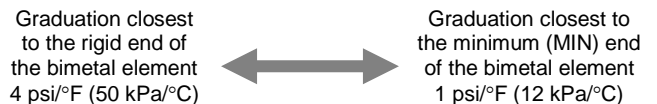

**NOTE:** If the thermostat sensitivity is adjusted, recalibrate the thermostat.

## Thermostat Calibration

The thermostat is factory calibrated to a control pressure of 7.5 psi (52 kPa) when the set point and the ambient temperature are both at 72°F (22°C). No adjustments are required if these settings are appropriate.

If the thermostat has been tampered, the sensitivity changed, or it is out of adjustment, use the following procedures to recalibrate the instrument.

The output pressure test port (*Figure 4*) is accessible without removing the thermostat cover through the 8th opening:

- For TH192 HC thermostats, the port is on the *left* side.



### CAUTION:

If you use the wrong test port, thermostat damage can occur and result in replacement of the device.

## Cooling Calibration

1. Remove the cover using the calibration tool. Verify that the room temperature is between 70 and 80°F (21 and 27°C).
2. Verify that the supply pressure is 18 psi (124 kPa). Set the cooling dial to the room temperature by turning the exposed adjustment knob or using a hex key. Allow the thermostat to stand for about five minutes to adjust to the new setting.

- Moisten the needle and insert the test gauge and needle adapter in the test port (Figure 4). Read the control pressure.
- If the control pressure does not read 7 to 8 psi (48 to 55 kPa), turn the calibration screw (Figure 3) using the calibration tool or a 1/8" (3.2 mm) wrench until the pressure is 7 to 8 psi (48 to 55 kPa). The sensing element is now in calibration and the set point can be changed to the desired room temperature.

### Heating Calibration

- If not already done, remove the cover using the calibration tool. Verify that the room temperature is between 70 and 80°F (21 and 27°C).
- Verify that the supply pressure is 25 psi (172 kPa). Set the heating dial to the room temperature by turning the exposed adjustment knob or using a hex. Allow the thermostat to stand for about five minutes to adjust to the new setting.
- Moisten the needle and insert the test gauge and needle adapter in the test port (Figure 4). Read the control pressure.
- If the control pressure does not read 7 to 8 psi (48 to 55 kPa), turn the calibration screw (Figure 3) using the calibration tool or a 1/8" (3.2 mm) wrench until the pressure is 7 to 8 psi (48 to 55 kPa). The sensing element is now in calibration and the set point can be changed to the desired room

### Reference

Document	Number
TH192-2, TH192 HC Heating/Cooling Room Thermostat Technical Instructions	155-066P25
TB 214, TH192 Adapter Kits Technical Bulletin	155-231
TB 237, Accessories for Installation of TH192, TH193, or TH194 Room Thermostats Technical Bulletin	155-244
Powerstar Thermostat Covers — Color Reference Guide	152-178P10

### Troubleshooting

Before troubleshooting the thermostat per Table 1, make certain there is clean dry supply air at 18 psi (124 kPa) minimum. Use the test probe gauge and needle adapter to measure the control pressure at the output pressure test port (Figure 4). The output pressure test port is accessible without removing the thermostat cover through the 8th opening from the top as follows:

- For TH192 HC thermostats, the port is on the left side.



#### CAUTION:

If you use the wrong test port, thermostat damage can occur and result in replacement of the device.

Table 1. Troubleshooting Guide.

Problem	Check	Cause	Action
Control pressure stays at approximately zero	Air supply	Low supply pressure	As required
	Nozzle or flapper	Dirt on nozzle or flapper	Clean nozzle or replace thermostat
	Restrictor	Clogged restrictor	Replace restrictor
	Calibration	Out of calibration	Recalibrate
Control pressure stays at approximately supply pressure	Nozzle	Clogged nozzle	Clean nozzle or replace thermostat
	Calibration	Dirt on either supply or exhaust valve seat	Alternately close and open nozzle by gently pushing down the bimetal
Excessive air leakage from exhaust port on left side of thermostat	Supply and return line connection	Connections are interchanged or connection to port is incorrect	As required

### Dimensions

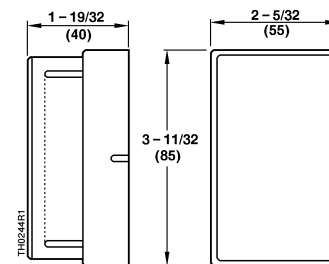

Figure 5. TH192 HC Dimensions in Inches (Millimeters).

Information in this publication is based on current specifications. The company reserves the right to make changes in specifications and models as design improvements are introduced. Product or company names mentioned herein may be the trademarks of their respective owners. © 2009 Siemens Industry, Inc.