

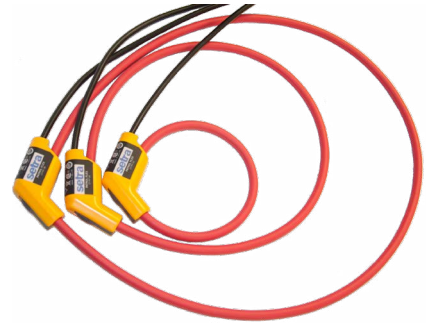

## Patrol Flex Rogowski Coil Safety Information/Operating Instructions



### INTRODUCTION

Offered in 12", 24" and 36" lengths, the Patrol Flex is the most accurate Rogowski Coil in submetering. Rogowski Coils offer significant installation advantages over split-core CT's because of its light weight, wide current range (10-4000+ Amps), mechanical flexibility for mounting in tight quarters and its easy placement around cable bundles or large bus bars.

The Setra Patrol Flex is an AC current probe utilizing the Rogowski principle. The flexible and lightweight measuring head allows quick and easy installation in hard to reach areas, without batteries or an external power source. The Flex clamp fits around bus bars and large or hard-to-reach conductors.

### SAFETY INSTRUCTIONS

Please read this section carefully. It will familiarize you with the most important safety instructions for handling the Probe. In this instruction sheet, a Warning identifies conditions and actions that pose hazard(s) to the user. A Caution identifies conditions and actions that may damage the calibrator or the test instrument.



The Probe may only be used and handled by qualified personnel. To avoid electric shock or personal injury, follow these precautions:

- Read all safety information before you use the Product.
- Do not apply to or remove from hazardous live conductors without taking additional protective measures.
- High voltages and currents may be present in adjacent circuits under test.
- Do not use the Probe if damaged. Always connect to display device before it is installed around the conductor.
- Use the Probe only as specified in the operating instructions; otherwise the safety features may not protect you.
- Adhere to local and national safety codes. Individual protective equipment must be used to prevent shock and arc blast injuries where hazardous live conductors are exposed.
- Before each use, inspect the Probe. Look for cracks or missing portions of the housing or output cable insulation. Also look for loose or weakened components.
- Use caution when working with voltages above 60V dc, 30V ac rms or 42V ac peak. Such voltages pose a shock hazard.
- Equipment is considered to be used in 600V CAT IV and 1000V CAT 111 environment. CAT IV equipment is designed to be used at the source of the distribution system up to the energy meter within the installation. CAT III equipment is designed to be used in distribution panels, feeders and short branch circuits, and lighting systems in large buildings.
- Do not use the Probe in damp or wet environments or in locations where hazardous gases may be present.

# OPERATING INSTRUCTIONS

1. Connect the Probe to the product terminal block.
2. Wear protective gloves or de-energize the circuit and place the coil around the conductor under test. Re-energize circuit.

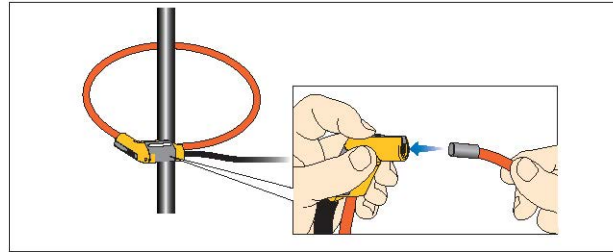

Locking the Coil

3. Positive output indicates that the current flow is in the direction shown by the arrow on the Probe. (arrow toward electrical load)



## Cleaning:

Clean the Probe periodically by wiping it with a damp cloth and detergent. Do not use abrasive cleaners or solvents. Do not immerse the Probe in liquids.

# SPECIFICATIONS

SPECIFICATIONS			
General Specifications		Specifications	
Probe and Cable Material	TPE rubber, reinforced insulation UL94 V-0, Colour: RED Munsell 7.5 R 1/14	Voltage Output (@1000 ARMS, 60 Hz)	111 mV
Couplings Material	Polypropylene, UL94 V-0	Current Range	6000 A AC RMS
Probe Cable Length	610 mm	Accuracy	± 1% of reading (@ 25°C, 60 Hz)
Probe Cable Diameter	12.4 mm	Linearity (10% to 100% of range)	± 0.2% of reading
Probe Cable Bend Radius	40 mm	Working Voltage (see Safety Standards section)	1000 V AC RMS or DC (head) 30 V max. (output)
Output Cable Length	2 meters shielded 2-wire cable	Safety Specifications	
Output Connector	Unterminated	Safety Standards	-BS EN 61010-1 2001 -BS EN 61010-2-032 2002 -BS EN 61010-031 2002, 1000 VRMS, Category III, Pollution Degree 2 -Use of the probe on uninsulated conductors is limited to 1000 V ACRMS or DC and frequencies below 1 kHz.
Operating Range	-20° to +70° C		
Storage Temperature	-40° to +80° C		
Operating Humidity	15% to 85% (non condensing)		
Degree of Protection (Probe)	IP40		



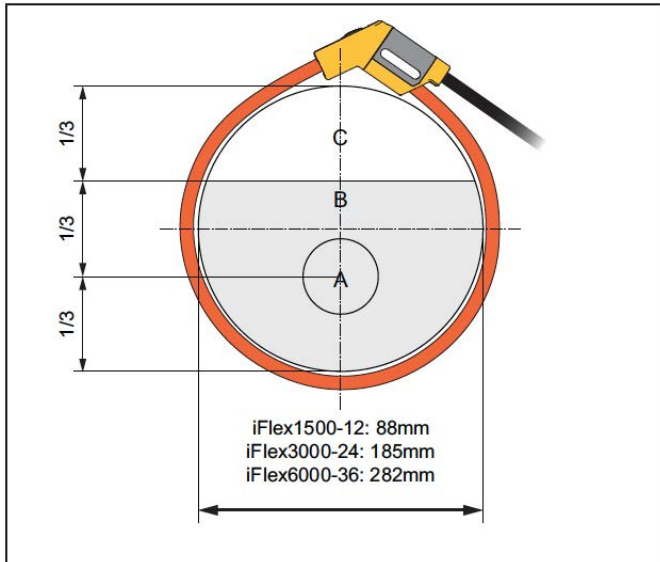



# PATROL FLEX SPECIFICATIONS



	Patrol Flex 12", 24", 36"
Probe Window A	± (1% of reading + 0.02% of range)
Probe Window B	± (1.5% of reading + 0.02% of range)
Probe Window C	± (2.5% of reading + 0.02% of range)

## SYMBOLS

The table below is a list of symbols used on the product or in this document.

Symbol	Meaning
	Risk of Danger, Important Information. See Manual.
	Hazardous voltage
	Double insulation
CAT II	Measurement Category II is applicable to test and measuring circuits connected directly to utilization points (socket outlets and similar points) of the low-voltage MAINS installation.
CAT III	Measurement Category III is applicable to test and measuring circuits connected to the distribution part of the building's low-voltage MAINS installation.
CAT IV	Measurement Category IV is applicable to test and measuring circuits connected at the source of the building's low-voltage MAINS installation.
	Conforms to European Union directives.
	Conforms to relevant North American Safety Standards
	Conforms to relevant Australian EMC requirements.
	This product complies with the WEEE Directive (2002/96/EC) marking requirement. The affixed label indicates that you must not discard this electrical/electronic product in domestic household waste. Product Category: With reference to the equipment types in the WEEE Directive Annex I, this product is classed as category 9 "Monitoring and Control Instrumentation" product. Do not dispose of this product as unsorted municipal waste.

# LIMITED WARRANTY AND LIMITATION OF LIABILITY

## WARRANTY AND LIMITATION OF LIABILITY

SETRA warrants its products to be free from defects in materials and workmanship, subject to the following terms and conditions: Without charge, SETRA will repair or replace products found to be defective in materials or workmanship within the warranty period; provided that: a) the product has not been subjected to abuse, neglect, accident, incorrect wiring not our own, improper installation or servicing, or use in violation of instructions furnished by SETRA;

b) the product has not been repaired or altered by anyone except SETRA or its authorized service agencies c) the serial number or date code has not been removed, defaced, or otherwise changed; and

d) examination discloses, in the judgment of SETRA, the defect in materials or workmanship developed under normal installation, use and service; e) SETRA is notified in advance of and the product is returned to SETRA transportation prepaid. Unless otherwise specified in a manual or warranty card, or agreed to in writing and signed by a SETRA officer, SETRA pressure, humidity, and acceleration products shall be warranted for one year from date of sale.

The foregoing warranty is in lieu of all warranties, express, implied or statutory, including but not limited to, any implied warranty of merchantability for a particular purpose. SETRA's liability for breach of warranty is limited to repair or replacement, or if the goods cannot be repaired or replaced, to a refund of the purchase price. In no instance shall SETRA be liable for incidental or consequential damages arising from a breach of warranty, or from the use or installation of its products. No representative or person is authorized to give any warranty other than as set out above or to assume for SETRA any other liability in connection with the sale of its products.

For all CE technical questions, contact Setra Systems, USA. EU customers may contact our EU representative Hengstler GmbH, Umlandstr 49, 78554 Aldingen, Germany (Tel: +49-7424-890; Fax: +49-7424-89500).