



ANALOG RESCALING MODULE INTERFACE SERIES

Installation & Operation Instructions

ARM

Phone: 1-888-967-5224

Website: workaci.com

GENERAL INFORMATION

The ARM is an analog rescaling module which accepts an analog (voltage or current) input signal and rescales it to another voltage or current output signal. The top-adjust trimmer potentiometers can be used to make fine adjustments to output ranges for maximum flexibility. This device can attenuate an input signal to 100%. The ARM also has an adjustable gain and offset. The output gain can be adjusted from 1 to 25 times the input (gain will vary depending on input). The offset of the output can be adjusted anywhere from 0 to +/- 20 VDC. The ARM also has the ability to reverse an input signal. The ARM has a regulated 20 VDC power supply output to power sensors. The ARM can also accept a resistance input by using voltage divider applications. The ARM is field calibratable, however, factory calibration is available upon request for an additional charge. This will speed up installation time for the end user.

MOUNTING INSTRUCTIONS

Circuit board may be mounted in any position. If circuit board slides out of snap track, a nonconductive "stop" may be required. Use only fingers to remove board from snap track. Slide out of snap track or push against side of snap track and lift that side of the circuit board to remove. **Do not flex board or use tools.**

WIRING INSTRUCTIONS

PRECAUTIONS

- **Remove power before wiring. Never connect or disconnect wiring with power applied.**
- **When using a shielded cable, ground the shield only at the controller end. Grounding both ends can cause a ground loop.**
- **It is recommended you use an isolated UL-listed class 2 transformer when powering the unit with 24 VAC. Failure to wire the devices with the correct polarity when sharing transformers may result in damage to any device powered by the shared transformer.**
- **If the 24 VDC or 24VAC power is shared with devices that have coils such as relays, solenoids, or other inductors, each coil must have an MOV, DC/AC Transorb, Transient Voltage Suppressor (ACI Part: 142583), or diode placed across the coil or inductor. The cathode, or banded side of the DC Transorb or diode, connects to the positive side of the power supply. Without these snubbers, coils produce very large voltage spikes when de-energizing that can cause malfunction or destruction of electronic circuits.**
- **All wiring must comply with all local and National Electric Codes.**

FIGURE 1: DIMENSIONS

BOARD

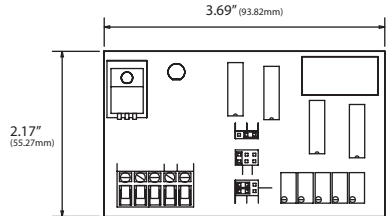

SNAP TRACK

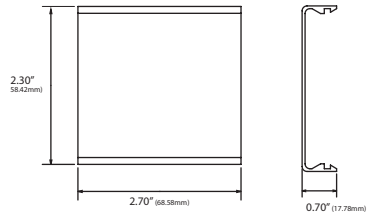
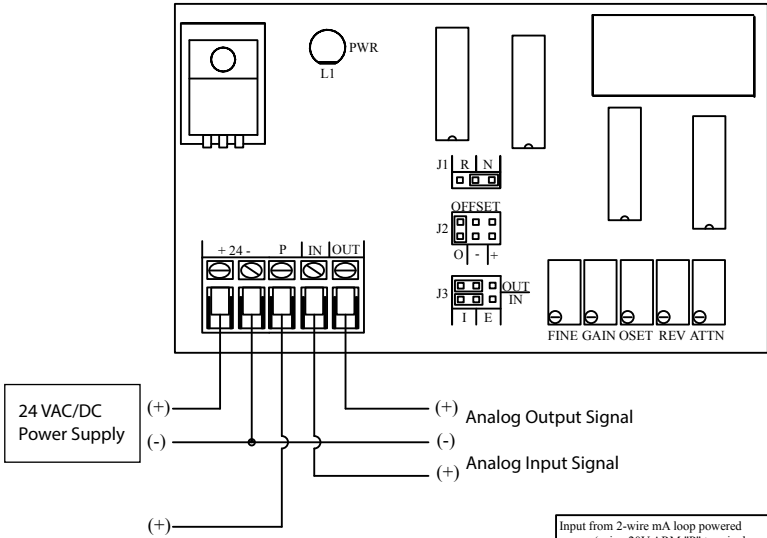

FIGURE 2: WIRING



Note: 20VDC Regulated Accessory Power output used for resistance to analog conversions

Note: The ARM does NOT isolate the input signals from the output. Use the Analog Isolation Module (AIM1, AIM2, or AIM3) if you need to isolate the signal from the device being controlled.

FACTORY CALIBRATION

The ARM is set as follows:

- No Attenuation to the Input Signal
- Voltage Input Signal
- Voltage Output Signal
- Normal Acting Output Signal
- No Offset to the Output Signal
- Gain of 1 to the Output Signal (1:1)

The ARM can be ordered calibrated to your specifications or you may follow the procedure below to set your own calibration.

Be sure to check the input, output, GAIN and OFFSET specifications of the ARM. It is possible that the ARM cannot re-scale to your requirements.

Calibration

Complete the following steps to change the calibration of the ARM. You will need a digital volt/current meter, a 24 VDC power supply and a voltage input signal simulator. (A 5K ohm or greater trim pot can be used as a voltage input signal simulator by connecting one end of the trim pot resistance winding to the (+) 24 of the power supply, the other end of the trim pot resistance winding to the (-) 24 of the power supply and the wiper end of the trim pot to the "IN" terminal of the ARM).

EQUIVALENT CALIBRATION VOLTAGE

Use a voltage signal for your input signal during calibration: this makes both the procedure and the explanation easier. If you will require a current input when you are finished, use the equation below to find the equivalent calibration voltage to use during the calibration procedure:

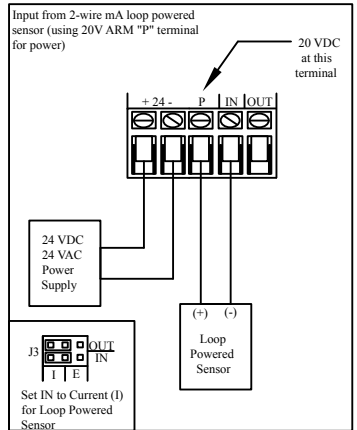

EQUIVALENT CALIBRATION VOLTAGE (Continued)

Equivalent Calibration Voltage = Required Input Signal Amps x 250

Example: 1 VDC is the equivalent calibration voltage for a 4 milliamp input signal ($1 = .004 \times 250$) or 5 VDC is the equivalent calibration voltage for a 20 milliamp input signal ($5 = .020 \times 250$).

Step 1) Trim Pot Presets Set all pots as follows to start (These are multi-turn trim pots with no hard stops; they may make a slight clicking sound at either end of their range):

Turn the following pots full clockwise (25 turns): GAIN = gain of 1

FINE

OFFSET = 0 volts offset

REV = 0 volts reverse

Turn the following pot Full Counterclockwise (25 turns): ATTN = (no input signal attenuation)

Step 2) Jumper Shunt Presets

J1 - NORMAL OR REVERSE ACTING: Set in "N" position for direct acting output signal. (If you require a reverse acting output signal, you will set this shunt in the "R" position in Step 7).

J2 - OFFSET: Set in the "O" position for no offset to the output. (If you will require a "+" or "-" offset, you will set this shunt in the appropriate position in Step 6).

J3 IN - INCOMING SIGNAL VOLTAGE OR CURRENT: Set in "E" position for voltage input. (If you require a current input, you will set this shunt in the "I" position AFTER you are finished with the calibration procedure).

J3 OUT - OUTGOING SIGNAL VOLTAGE OR CURRENT: Set in "E" position for voltage output (If you require a current output, you will set this shunt in the "I" position AFTER you are finished with the calibration procedure).

FIGURE 3: JUMPER SHUNTS

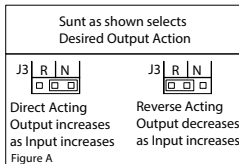
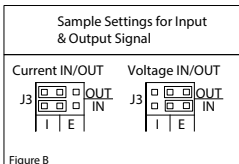
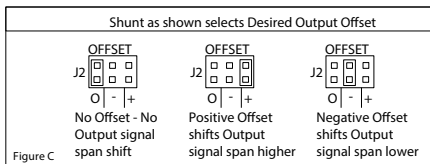

Step 3) Wiring Connections

Make the following connections with the power OFF:

Connect a 24 volt AC or DC power supply to the ARM terminals "+24" and "-24".

Connect the input signal common (-) and the (-) meter lead to the "-24" terminal. Connect (+) input signal lead to the "IN" terminal.

Connect (+) meter lead to the "OUT" terminal.

Step 4) Power Up

Turn on the 24 volt power supply: the POWER indicator will light.

Step 5) Input/Output Signal Adjustments

In this step you will figure the desired voltage input signal span and the desired voltage output signal span (see the section on Equivalent Calibration Voltage) and calibrate the ARM to these input and output signal spans.

EQUIVALENT CALIBRATION VOLTAGE (Continued)

To calculate the voltage input signal span, subtract the minimum voltage input signal from the maximum input signal (i.e. a 0 to 5 volt input signal will give you a 5 volt input signal span: $5-0=5$).

To calculate the voltage output signal span, subtract the minimum voltage output signal from the maximum voltage output signal (i.e. a 3 to 15 volt output signal will give you a 12 volt output signal span: $15-3=12$).

Take the number for the voltage input signal span and apply this voltage to "IN" terminal. Compare the output voltage reading on your meter with the voltage output signal span you calculated above. If the meter reading is higher, adjust the "ATTN" trim pot until the meter reading drops to the calculated output span. If the meter reading is lower, adjust the "GAIN" and "FINE" trim pots until the meter reading increases to the calculated output signal span.

Step 6) Offset Adjustments

The offset adjustments simply shift the output signal range up or down from a "no offset" condition.

Example: An output signal range in a "no offset" condition is 3 to 15 volts. Adding an offset of 2 volts would make the output signal range 5 to 17 volts or subtracting an offset of 2 volts would make the output signal range 1 to 13 volts.

Apply the minimum voltage input signal and read the minimum output signal on the meter. With the "OFFSET" jumper shunt "J2" in the "O" position (from Step 6), no offset voltage will be added or subtracted from the output signal range.

If you need to shift the output signal range up, set the "OFFSET" jumper shunt "J2" in the "+" position and adjust the "OFFSET" trim pot until you increase the voltage reading on the meter to match the desired minimum output voltage. (Remember, this also increases the maximum output signal by the same amount.)

If you need to shift the output signal range down, set the "OFFSET" jumper shunt "J2" in the "-" position and adjust the "OFFSET" trim pot until you decrease the voltage reading on the meter to match the desired minimum output voltage. (Remember, this also decreases the maximum output by the same amount.)

Step 7) Reverse Action Adjustments

If you will require your output signal to reverse act, set jumper shunt "J1" in the "R" position. Apply the minimum voltage input signal and adjust the "REV" trim pot for the highest desired output signal. Check the low, mid-scale and high signal points to insure proper calibration.

Step 8) Final Adjustments

If you require a current input, set the "J3" IN jumper shunt in the "I" position. If you require a current output, set the "J3" OUT jumper shunt in the "I" position. Check operation of the ARM for desired signal re-scaling and operation.



ARM CALIBRATION WORK SHEET : Fill in and circle answers.

1. Input: minimum _____ maximum _____ mA or VDC, Output: minimum _____ maximum _____ mA or VDC

2. Is the input VDC? Yes/No. Is the output VDC? Yes/No

- If yes to both, set jumper J3 (IN/OUT) to E and skip to step 5.
- If no to both, set jumper J3 (IN/OUT) to I and skip to step 5.
- If yes to only one, continue to step 3.

3. Is current the input signal? If no, skip to step 4. If yes, perform the following:

- Set J3 (IN) to I and (OUT) to E.
- Multiply input minimum by 250 and enter value in "Input minimum" in step 5a.
- Multiply input maximum by 250 and enter value in "Input maximum" in step 5a.

Example : minimum=4mA = $.004 \times 250 = 1$ VDC and maximum=20mA = $.020 \times 250 = 5$ VDC.

4. Is voltage the input signal. If no, skip to step 5. If yes,

- Set J3 (IN/OUT) to E. Output jumper will be changed to I in later steps.
- Multiply output minimum by 250 and enter value in "Output minimum" in step 5b.
- Multiply maximum by 250 and enter value in "Output maximum" in step 5b.

Example : minimum 4mA = $.004 \times 250 = 1$ VDC and maximum 20mA = $.020 \times 250 = 5$ VDC.

5. Enter mA, VDC or equivalent values below. Note: Do not mix voltage and current.

- Input minimum _____ Input maximum _____ maximum-minimum = Input span _____
- Output minimum _____ Output maximum _____ maximum-minimum = Output span _____

6. Preset trimpots: 25 Turns until it clicks.

25 Turns Clockwise - Gain, Fine, Offset and Reverse

25 Turns Counter clockwise – Attenuation

7. Make all connections including signal generator and multimeter. Apply power (24 VAC or VDC).

8. Set jumpers J2 to 0 and J1 to N

9. First test: input a 50% signal. Is the input equal to or close to the output?

If yes, proceed to step 10.

If no, return to step 7.

Note: Min, max and span values are found in step 5.

10. Supply the "input span" signal or equivalent to the input. (Refer to step 5).

- If the "input span" is less than "output span", turn the gain or fine trim pot until the output is equal to the "output span" signal.
- If the "input span" is greater than "output span", turn the attenuation trim pot until the output is equal to the "output span" signal.

11. Setting the offset jumper:

- If the "input minimum" is greater than "output minimum" Set J2 to (-). Skip to 12.
- If the "input minimum" is less than "output minimum" Set J2 to (+). Skip to 12.
- If the "input minimum" is equal to "output min" Leave J2 alone and skip to step 12.



12. Supply the "input minimum" signal or equivalent to the input. Adjust the offset trim pot until the output reads the same as "output minimum".

13. Is signal reverse acting? If not skip to step 14. If yes, refer to following:

a) Set J1 to R.

b) Supply "input minimum", or equivalent, and adjust the Rev trim pot until reading is equal to output maximum.

14. If the output is current. Set J3 (out) to I and reset meter to current. ($V_{out} / 250 = mA$).

15. Check the low, mid-scale and high signal points to check output for proper calibration. Fine calibration adjustments may now be made.



PRODUCT SPECIFICATIONS

NON-SPECIFIC INFORMATION	
Supply Voltage:	24 VAC or 24VDC, (+/- 10%), 50/60 Hz
Supply Current:	200 mA maximum
Input Voltage Signal Range (@ Impedance):	0 to 35 VDC @ 1MΩ
Input Current Signal Range (@ Impedance):	0-44 mA @ 250Ω
Input Resistance Signal Range:	0 to 500,000Ω
Field Adjustable Ranges:	Multi-turn potentiometers
Output Voltage Signal Range:	0.25 VDC minimum to 20 VDC maximum
Output Current Signal Range:	44 mA maximum, Signal Gain 1 to 25 times (nominal) depending on input value
Output Accuracy:	+/- 1%
Output Signal Attenuation:	0 to 100%
Output Signal Offset:	0.25 to 20 VDC
Output Signal Inversion (RA):	20 to 0.25 VDC (nominal)
Output Current Load Impedance:	750Ω @ 20 mA
Output Voltage Load Impedance:	3300Ω @ 20 VDC +/- 10% / 400Ω @ 10 VDC +/- 10%
Regulated Power Output:	20 VDC +/- 10%, 30 mA maximum
Connections:	45° Captive screw Terminal Blocks
Wire Size:	12 (3.31 mm ²) to 22 AWG (0.33 mm ²)
Terminal Block Torque Rating:	0.5 Nm (Minimum); 0.6 Nm (Maximum)
Operating Temperature Range:	35 to 120°F (1.7 to 48.9°C)
Operating Humidity Range:	10 to 95% non-condensing
Storage Temperature:	-20 to 150°F (-28.9 to 65.5°C)
Snaptrack Material:	Polyvinyl Chloride (PVC)
Snaptrack Flammability Rating:	UL94 V-0
Agency Approvals:	RoHS2, WEEE

WARRANTY

The ARM Series is covered by ACI's Two (2) Year Limited Warranty, which is located in the front of ACI'S SENSORS & TRANSMITTERS CATALOG or can be found on ACI's website: www.workaci.com.

W.E.E. DIRECTIVE

At the end of their useful life the packaging and product should be disposed of via a suitable recycling centre. Do not dispose of with household waste. Do not burn.



NOTES



Automation Components, Inc.

2305 Pleasant View Road
Middleton, WI 53562

Phone: 1-888-967-5224

Website: workaci.com

