



# HW2 Analog Series

## Wall Mount Humidity Sensors

### Product Overview

The HW2 Series of humidity sensors for living space is a flexible multisensor platform for use with BAS controllers designed to accept 4 to 20mA, 0 to 5Vdc or 0 to 10Vdc outputs. HW2 Series sensors are available with three user interface options: touchscreen, LCD with three buttons and blank. Humidity and temperature sensors are included with all HW2 Series sensors.

### Product Identification

User Interface	Output	RH Accuracy*	Temperature
HW2			
T = Color touchscreen L = 3-button LCD display X = None	A = Analog output	2 = 2%	A = Transmitter only C = 1000 PT RTD D = 10K T2 thermistor G = 10K CPC thermistor** H = 10K T3 thermistor K = 10K curve G/11K shunt M = 20K NTC thermistor N = 1.8K TAC thermistor R = 10K curve G***

\* Replaceable RH module available to be ordered separately per table below.  
 \*\* Available in HW2XA2G only.  
 \*\*\* Available in HW2XA2R only.

### Replaceable RH Elements

Model	RH Accuracy	Calibration Certificate	Description
HS1N	±1%	X	Replaceable RH sensor, 1% with NIST certification
HS2N	±2%	X	Replaceable RH sensor, 2% with NIST certification
HS2X	±2%		Replaceable RH sensor, 2%

### Specifications

OPERATING ENVIRONMENT	
<b>Input Power</b>	Class 2; 20 to 30 Vdc, 24 Vac, 50 to 60 Hz
<b>Analog Output</b>	Selectable 4 to 20 mA, 0 to 5 V, 0 to 10 V
<b>Operating Temp. Range</b>	0 to 50 °C (32 to 122 °F)
<b>Operating Humidity Range</b>	0 to 95% RH non-condensing
<b>Housing Material</b>	High-impact ABS plastic
<b>Terminal Block Torque</b>	0.5 to 0.6 N-m (0.37 to 0.44 in-lbf)
<b>IP Rating</b>	IP 30
<b>Mounting Location</b>	For indoor use only. Not suitable for wet locations.
<b>Surface Mount</b>	The device can be surface mounted on Single Gang J-Box, British Standard and CE60 wall boxes



**WARNING**

**HAZARD OF ELECTRIC SHOCK, EXPLOSION OR ARC FLASH**

- Apply appropriate personal protective equipment (PPE) and follow safe electrical work practices. See NFPA 70E or CSA Z462.
- This equipment must only be installed and serviced by qualified electrical personnel.
- Turn off all power supplying this equipment before working on or inside equipment.
- Always use a properly rated voltage sensing device to confirm power is off.
- Replace all devices, doors and covers before turning on power to this equipment.

**Failure to follow these instructions can result in death, serious injury or equipment damage.**

This product is intended for use in HVAC and building environmental control applications. It is not intended for direct medical monitoring of patients. Read and understand these instructions before installing this product. The installer is responsible for all applicable codes. If this product is used in a manner not specified by the manufacturer, the protection provided by the product may be impaired. No responsibility is assumed by the manufacturer for any consequences arising out of the use of this material.

Specifications (cont.)

<b>RH TRANSMITTER</b>	
<b>HS Sensor</b>	Solid state capacitive, replaceable
<b>Accuracy*</b>	±2% from 10 to 80% RH @ 25°C (77 °F)
<b>Hysteresis</b>	1.5% typical
<b>Stability</b>	±1% @ 20°C (68 °F) annually for 2 years
<b>Output Range</b>	0 to 100% RH
<b>Temperature Coefficient</b>	±0.1% RH/°C above or below 25 °C (77 °F) typical
<b>TEMPERATURE TRANSMITTER OPTION</b>	
<b>Sensor Type</b>	Solid state, integrated circuit
<b>Accuracy</b>	±0.2 °C (±0.4 °F) typical
<b>Resolution</b>	0.1 °C (0.1 °F)
<b>Range</b>	0 to 50 °C (32 to 122 °F)
<b>DISPLAY MODELS</b>	
<b>Touchscreen</b>	61 mm (2.4 in), color, backlit, capacitive, 240x300 px Setpoint: 0-10Vdc. Temperature, humidity or fan speed selectable Timeout override: Display timeout** Lockout override: Touchscreen/button lockout**
<b>LCD</b>	52mm (2.05 in), segmented with 3 buttons Setpoint: 0-10Vdc. Temperature, humidity or fan speed selectable Timeout override: Display timeout** Lockout override: Touchscreen/button lockout**
<b>SETPOINTS***</b>	
<b>Temperature Setpoint</b>	0 to 10V output Scale: 10 to 35 °C (50 to 95 °F) / 0 to 50 °C (32 to 122 °F)
<b>Humidity Setpoint</b>	0 to 10V output Scale: 0 to 100% RH
<b>Fan Speed Setpoint</b>	0 to 10V output Off 0V, Auto 1.5V, Low 3.3V, Med. 6.7V, High 10.0V
<b>OVERRIDE</b>	
<b>Override Button</b>	Display models feature a momentary-to-ground override button
<b>WIRING TERMINALS</b>	
<b>Terminal Blocks</b>	Screw terminals, 18-24 AWG
<b>Screw Terminal Torque</b>	0.2 N-m (2.0 in-lbf) max.
<b>WARRANTY</b>	
<b>Limited Warranty</b>	5 years
<b>COMPLIANCE INFORMATION</b>	
<b>Agency Approvals</b>	UL 916, European conformance CE: EN61000-6-2, EN61000-6-3, EN61000 Series - industrial immunity, EN 61326-1 FCC Part 15 Class B, REACH, RoHS, RCM (Australia), ICES-003 (Canada), UKCA (UK)

\* Humidity sensor measurement uncertainty should include: accuracy, hysteresis, temperature coefficient and stability.

\*\* DIP switch selectable.

\*\*\* One setpoint type is selectable via DIP switch on display models only.

## Dimensions

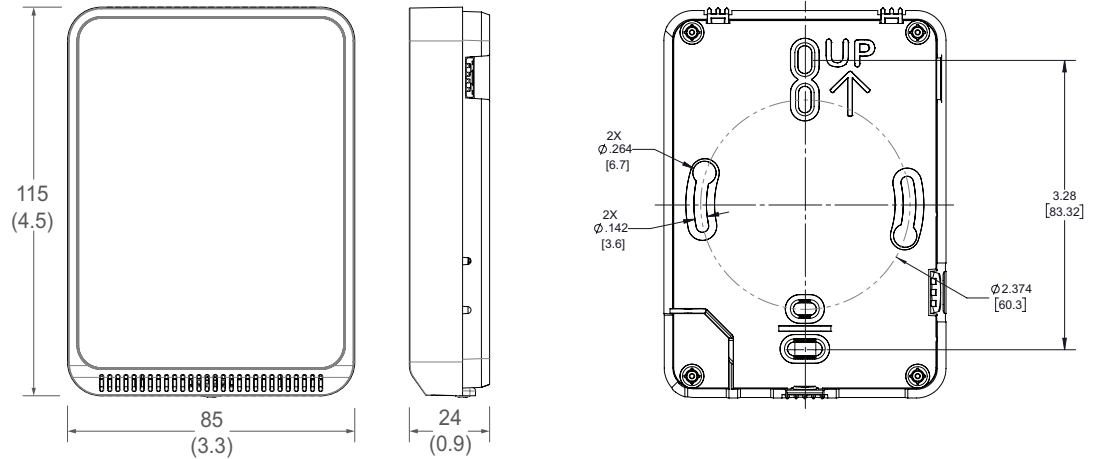

## Functions

The HW2 Series sensor measures the RH and temperature in a room and provides analog outputs to a controller.

## Installation

1. Remove the cover from the base at the bottom of the device.



2. Position the sensor base vertically on the wall 1.35 m (4.5 ft.) above the floor with the “UP” arrow facing upward. Locate away from windows, vents and other sources of draft. If possible, do not mount on an external wall, as this may cause inaccurate temperature readings.

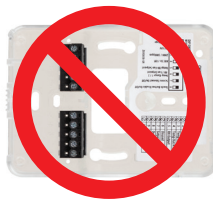

3. Pull 18 or 22 AWG cable(s) through the hole in the backplate.

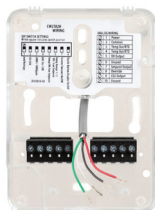

## Installation (cont.)

4. Mount the backplate onto the wall using the screws provided.

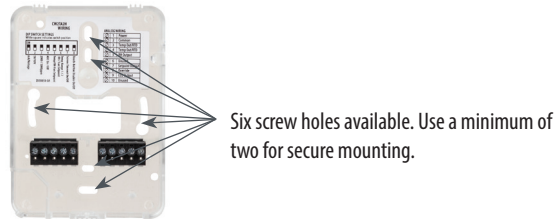

5. Connect the wires to the screw terminals. Do not over-tighten the screws.

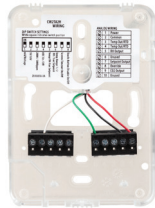

Wiring for models with temperature transmitter:

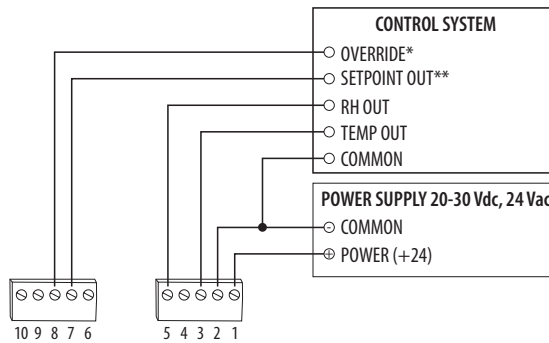

Wiring for models with RTD/thermistor:

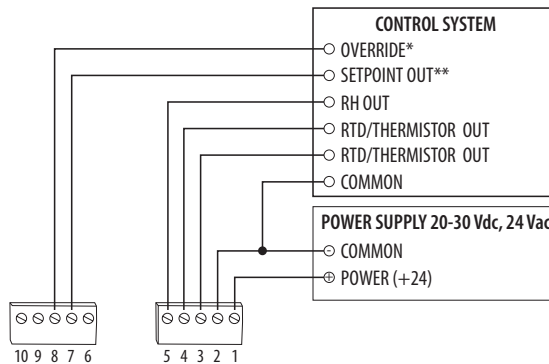

\* Momentary to ground.

\*\* 0-10V DIP switch selectable for temperature, RH or fan speed (off, 0V, Auto 1.5V, Low 3.3V, Medium 6.7V or high 10V).

## Installation (cont.)

Set the DIP switches.

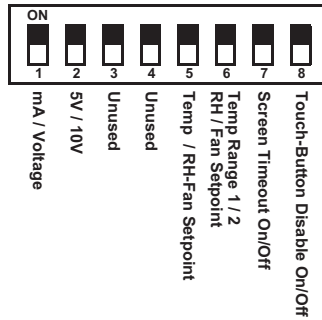

Switch	Function	Description
1	Output mode	ON - 4-20mA output mode enabled OFF - Voltage output mode enabled
2	Voltage output range*	ON - 0-5V output range enabled OFF 0-10V output range enabled
3	Unused	Unused
4	Unused	Unused
5	Setpoint output type	ON - Temperature setpoint enabled (temp range selected on DIP switch 6) OFF - RH or Fan Speed setpoint enabled (specific setpoint output type to be selected on DIP switch 6) Models without RH option select only temp or fan setpoint
6	Setpoint output temperature range or RH/Fan Speed output type	Temperature setpoint (must be enabled on DIP switch 5) ON - Temp range 1, 50 to 95 °F (10 to 35 °C) enabled OFF - Temp range 2, 32 to 122 °F (0 to 50 °C) enabled
		RH or Fan Speed setpoint (must be enabled on DIP switch 5) ON - RH setpoint enabled OFF - Fan Speed setpoint enabled Models without RH option, set to OFF
7	Display times out and turns off after 6-10 seconds of touchscreen/button press	ON - Display Timeout enabled OFF - Display Timeout disabled
8	Touchscreen touch functions and buttons are disabled	ON - Touchscreen touch/button functions disabled OFF - Touchscreen touch/button functions enabled

\* Only used with voltage output mode enabled. Not applicable to setpoint output. Setpoint is 0-10V fixed.

- With sensor base fully installed, align top of cover to mounting tabs on top of sensor base. Swing cover downward until it latches at the bottom.



## Installation (cont.)

7. Install locking screw to secure cover in closed position.



## Touchscreen Operation

### Main Screen

The touchscreen user interface displays applicable sensor output values (temperature and RH), setpoint value and menu button.

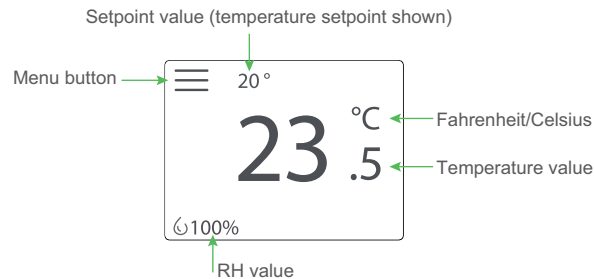

### Menu Screen

The menu screen opens when pressing the Menu button on the main screen. Integrator's submenu, occupancy/override, Fahrenheit/Celsius, settings and setpoint submenu (temp, RH or fan, determined by DIP switch settings) are displayed on the menu screen.



Temperature setpoint  
DIP switch selected

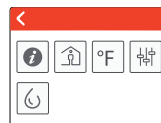

RH setpoint  
DIP switch selected

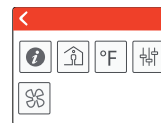

Fan Speed setpoint  
DIP switch selected

### Menu Button Functions



#### Integrator's Submenu

Press this icon to access the Integrator's menu.

#### Submenu Only

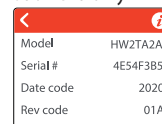

#### Occupied Override Button

Press this icon to provide momentary ground output to the controller

#### Single Press Only

Signals occupied/override call to controller.



#### Fahrenheit/Celsius Switch

Press this icon to display either °C or °F.

#### Single Press Only

Changes units to Fahrenheit when pressed.  
 Changes units to Celsius when pressed.

## Touchscreen Operation *Menu Button Functions (cont.)*

(cont.)



### Settings

This icon provides the ability to change the color scheme of the display.

#### Submenu Only

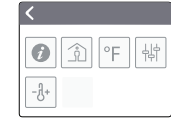
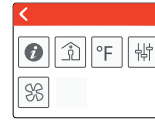
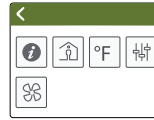
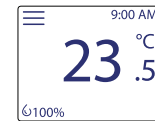
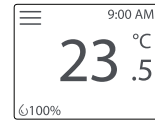

### Temp Setpoint Adjustment

Click this icon to access the setpoint change menu. Mutually exclusive with fan speed, set by DIP switch.

#### Submenu Only

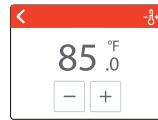

### Humidity Setpoint Adjustment

Click this icon to access the setpoint change menu. Mutually exclusive with humidity and fan speed. Set by DIP switch.

#### Submenu Only

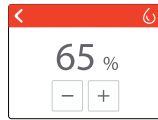

### Fan Speed

Click this icon to access the fan speed menu. Mutually exclusive with humidity and fan speed. Set by DIP switch.

#### Submenu Only



Selected

## LCD Display Operation *Button Functions*

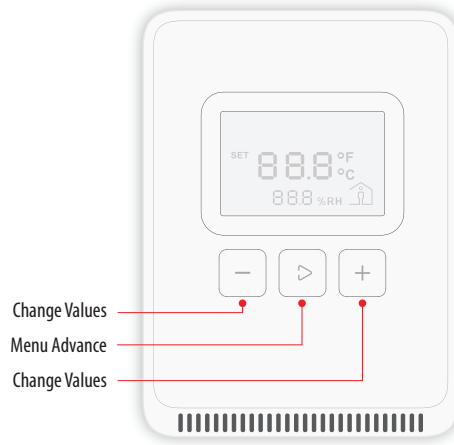

### *Display Icons*

The main screen displays sensor values for RH, temperature and Celsius/Fahrenheit.

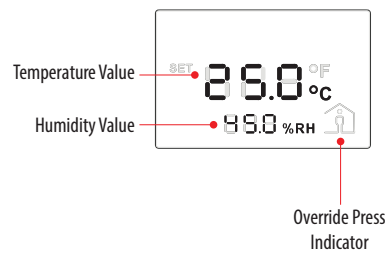

## Setpoint Function

A single 0-10V setpoint (temperature, RH or fan speed) can be selected via DIP switch.

### *Temperature Setpoint Adjustment*

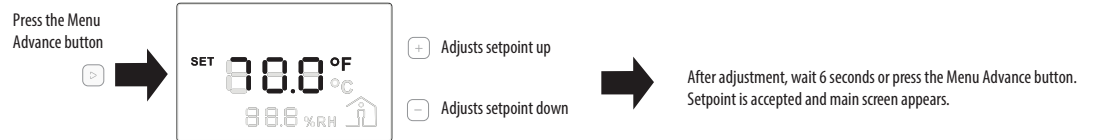

Note: Numeric information will flash while in Set mode.

### *RH Setpoint Adjustment*

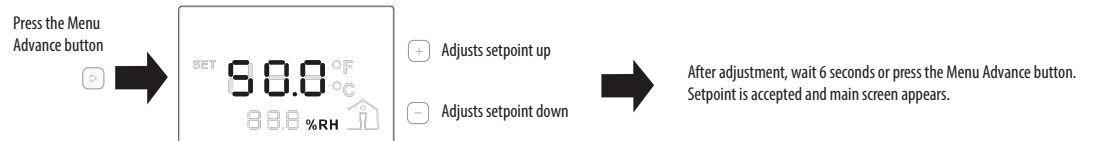

Note: Numeric information will flash while in Set mode.



## Setpoint Function (cont.)

### Fan Speed Setpoint Adjustment

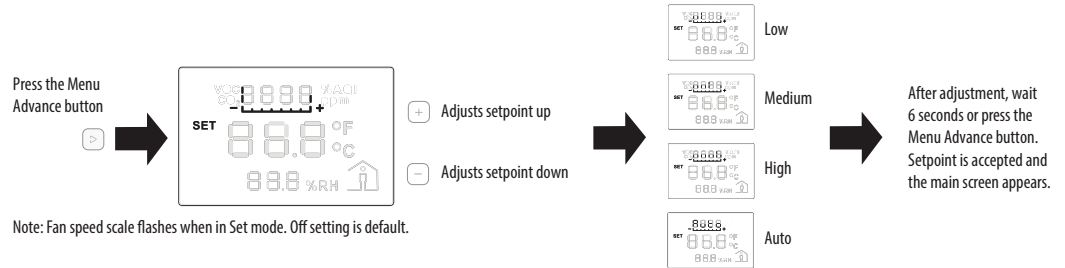

### Changing Celsius and Fahrenheit Scales

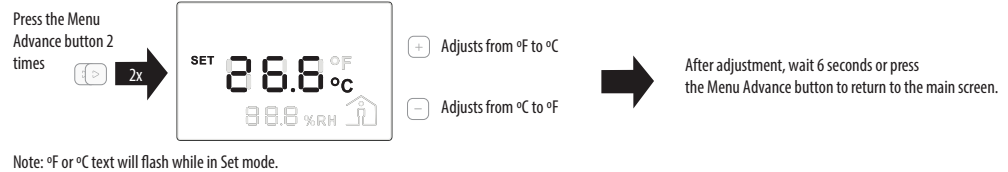

### Occupied/Override Button

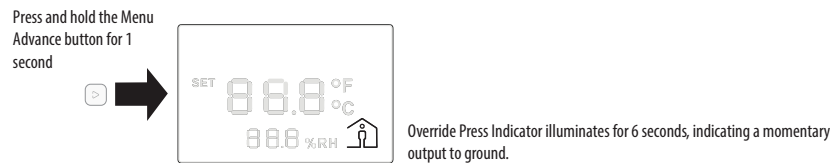

## China RoHS Compliance Information

### Environment-Friendly Use Period (EFUP) Table

部件名称	有害物质 - Hazardous Substances					
Part Name	铅 (Pb)	汞 (Hg)	镉 (Cd)	六价铬 (Cr (VI))	多溴联苯 (PBB)	多溴二苯醚 (PBDE)
电子件 Electronic	X	O	O	O	O	O

本表格依据SJ/T11364的规定编制。

O: 表示该有害物质在该部件所有均质材料中的含量均在GB/T 26572规定的限量要求以下。

X: 表示该有害物质至少在该部件的某一均质材料中的含量超出GB/T 26572规定的限量要求。

(企业可在此处，根据实际情况对上表中打“X”的技术原因进行进一步说明。)

This table is made according to SJ/T 11364.

O: indicates that the concentration of hazardous substance in all of the homogeneous materials for this part is below the limit as stipulated in GB/T 26572.

X: indicates that concentration of hazardous substance in at least one of the homogeneous materials used for this part is above the limit as stipulated in GB/T 26572

Z000057-0B