

3L Series Resilient Seated Butterfly Valves 2-Way — 2"- 24" and 3-Way — 2"- 20"

DOCUMENT	
CONTENTS	Features
	Valve Specs
	Sizing/Install Tips
	Piping Geometry
	Dimensions
	Close-Off's
LOOKING FOR MORE	
	© 2022 Bray International, Inc. 03/24/22

Application

Bray's 3L Series Nylon 11 coated and Stainless Steel disc resilient seated butterfly valves are designed for maximum reliability and low torque for the most efficient automation possible. Specifically designed for automated applications on chilled water, hot water and condenser water, all automated butterfly valves are 100% factory tested for bubble tight shut-off and industry leading low torque operation.

3L Series valves are available in 2-way configurations to 24" and 3-way configurations in sizes from 2" to 20". Actuators include industrial electric, commercial electric, high pressure pneumatic and low pressure pneumatic in both spring return and non spring return variations for On/Off and Modulating control applications. Differential pressure ratings are available for high Close-Off (up to 175 PSI) and low close-off (50 PSI) requirements.

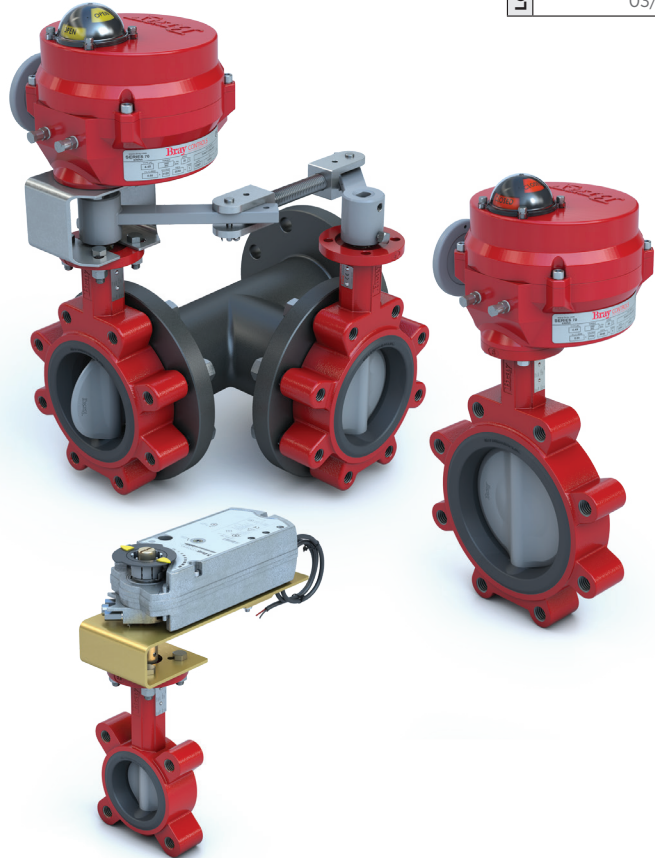

Features and Benefits

- **High purity Peroxide Cured EPDM seats**

Low torque and superior rubber stability over the shelf life and service life of the valve

- **Nylon coated ductile iron disc - NY Series**

*Superior corrosion and abrasion resistance extends the life of the valve
Reduced torque requirements*

- **Internal disc-to-stem connection**

High strength and easy serviceability

- **Wide variety of direct mount actuators**

Reduces size, cost and hysteresis

- **Full and 50 PSI close-off pressure ratings available**

For maximum actuator pricing efficiency

3L Series Butterfly Valves - Valve Body Specifications

Technical Specifications		
Service	Hot Water, Chilled Water, Condenser Water up to 50% Glycol	
Size Range	2-Way 3-Way	2" through 24" (DN 50 to 600) 2" through 20" (DN 50 to 500)
Body Style	One Piece Lug, 2-Way and 3-Way, for ANSI 125 and ANSI 150 flanges	
Flow Characteristics	Modified Equal Percentage - See Page 3L-3	
Flow Coefficients	See Page 3L-8	
Fluid Temperature Limits	-20 to 250 °F (-28 to 121 °C)	
Maximum Fluid Velocity	30 ft/second (9 m/second)	
Leakage	Bubble tight at rated maximum differential pressure	
Body Cold Working Pressure Ratings	250 PSI (17.2 Bar)	
Close-Off - Pressure Ratings Dead End Service Rated	2" to 12"	50 or 175 PSI
	14" to 24"	50 or 150 PSI
	Automated versions for 250 PSI Dead End rated service available.	
	See pages 3L-12 to 3L-22	
Materials (other materials available upon request)	Body	A536 Gr. 65-45-12 Ductile Iron
	Disc	3LNE Series - Nylon 11 coated 3LSE Series - 316 Stainless Steel
	Seat	EPDM (Ethylene Propylene Diene Monomer)
	Stem	416 Stainless Steel
	Tee	Ductile Iron (3-way valves only)
Weights	See Dimensions	
Approvals & Certifications	CE/PED Certification, ANSI/NSF 61 Certification, ANSI/NSF 372 Certification, ABS Type Approved, LRQA Type Approved, Bureau Veritas Approved	

Disclaimer - The performance specifications are nominal and conform to acceptable industry standards. For application at conditions beyond these specifications, consult the local Bray office. Bray, Inc. shall not be liable for damages resulting from misapplication or misuse of its products.

3L Series Butterfly Valves - Advantages

MOLDED-IN SEAT

Tightly controlled vulcanization process produces accurate and repeatable dimensions, which leads to consistently lower torques over the valve's lifetime.

PRECISION ENGINEERED PROFILED DISC SEALING EDGE

Extends the valve life by reducing seat wear.

ROBUST FLANGE SEALING

Tear-dropped shaped seat face enables tight sealing with a wide variety of industrial flanges.

END OF LINE SERVICE

Sealing at full rated differential pressure.

ISO 5211 TOP FLANGE

Direct mounting capability between the valve and Bray actuation reduces package height and complexity.

UPPER AND LOWER STEM BEARINGS

Reduce operating torque and increase reliability in high cycle applications.

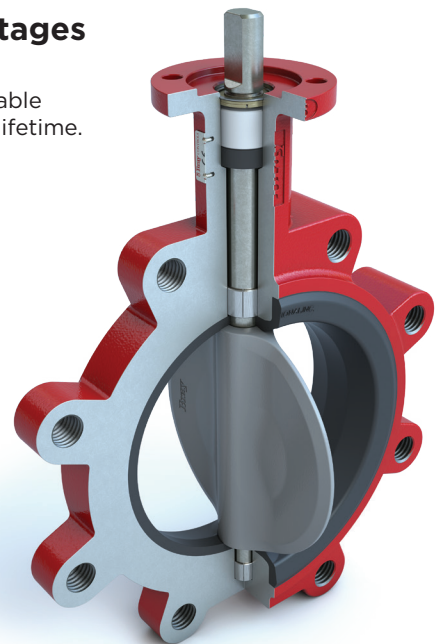

3L Series Butterfly Valves - Cv's at Various Angles of Openings

Low and Standard Pressure Cv Disc Values									
ANGLE OF DISC OPENING									
Valve Size	10°	20°	30°	40°	50°	60°*	70°	80°	90°
2"	1	1	15	29	46	66	73	86	87
2.5"	1	8	26	44	66	98	141	177	185
3"	2	22	43	71	112	171	256	338	360
4"	8	37	78	118	192	310	505	689	740
5"	9	53	98	170	288	470	759	1131	1218
6"	13	86	175	297	479	757	1190	1715	1900
8"	19	121	254	429	754	1247	2096	3376	3765
10"	37	178	365	728	1215	2005	3342	5814	6661
12"	69	240	492	1008	1696	2868	4961	8455	10066
14"	110	287	609	1141	1975	3328	5571	9269	11598
16"	147	421	844	1547	2651	4440	7412	12214	15395
18"	190	470	968	1807	3228	5509	9382	18231	20120
20"	230	675	1341	2455	4210	7056	11803	19637	25329
24"	317	952	1957	3592	6128	10267	17226	29061	39396

3L Series Butterfly Valves - Equal Percentage Flow Curve Chart

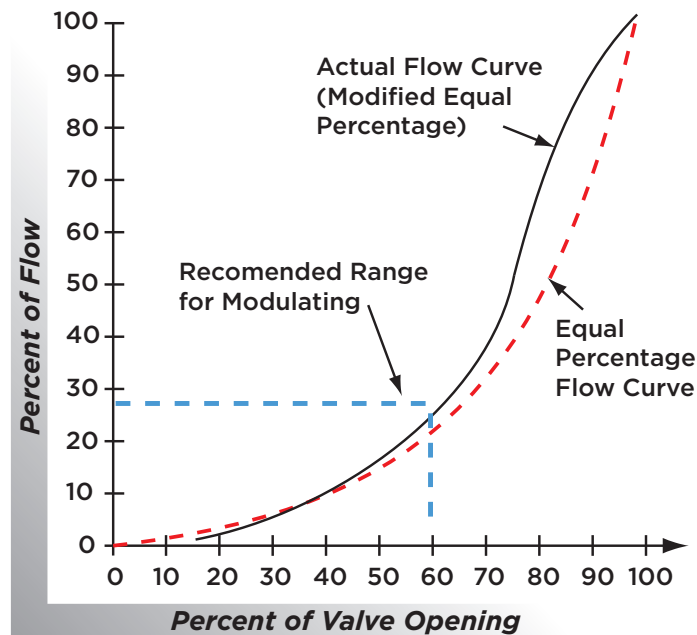

3L Series Butterfly Valves - Installation Tips

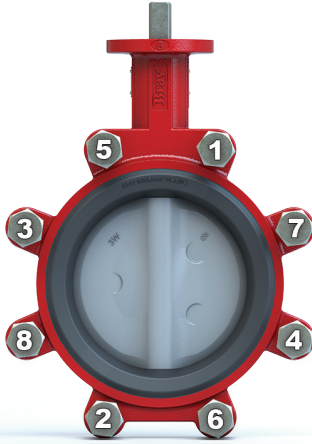

Valve Size	Bolt Size - inches	Maximum Bolt Torque Requirement (ft-lbs)
2" & 2.5"	5/8 - 11 Threads UNC-2B	30
3"	5/8 - 11 Threads UNC-2B	35
4"	5/8 - 11 Threads UNC-2B	35 - 40
5"	3/4 - 10 Threads UNC-2B	35 - 45
6"	3/4 - 10 Threads UNC-2B	35 - 50
8"	3/4 - 10 Threads UNC-2B	45 - 55
10"	7/8 - 9 Threads UNC-2B	55 - 75
12"	7/8 - 9 Threads UNC-2B	65 - 110
14" & 16"	1 - 8 Threads UN-2B	75 - 120
18" & 20"	1-1/8 - 8 Threads UN-2B	85 - 130
24"	1-1/4 - 8 Threads UN-2B	100 - 150

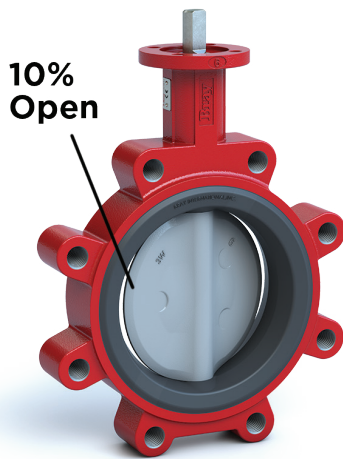

Lower the valve into the open pipe work with the disc in the 10° open position. Valves with non-spring actuators are shipped in this position.

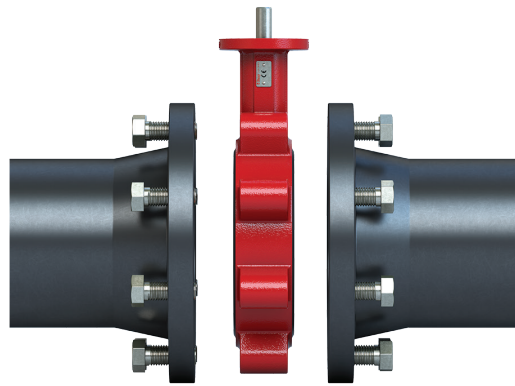

Once the valve is placed in the pipe work, turn the disc to the full-open position. Gradually remove the flange spreaders. Center the valve body to the flanges, and tighten the bolts hand-tight. Slowly close the valve clockwise to check for adequate disc clearance. Return disc to full-open position and cross tighten all bolts to proper torque specification (see tightening pattern above). DO NOT install with disc in fully closed position. This will cause seat distortion. When flange bolts are tightened, rubber will close around disc edge creating excessive torque in initial operation.

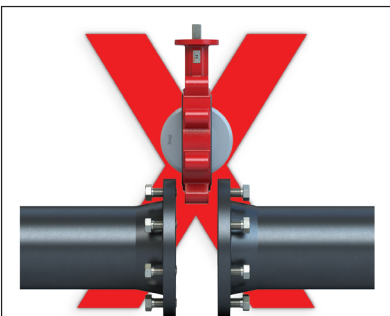

DO NOT lower the valve into the pipe with the pipe work spread in sufficiently or with the disc in the fully open position. This can lead to disc edge damage and can impact the flange.



DO NOT USE FLANGE GASKETS
The Butterfly Valve seat has a molded-in O-Ring that creates a positive seal against standard ANSI flange faces*.

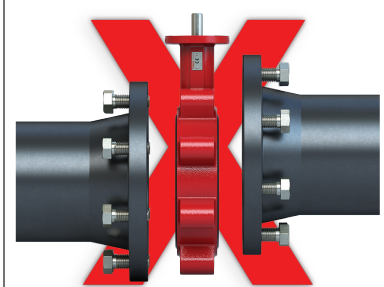

INCORRECT pipe alignment will cause interference between disc edge and flange face creating leakage, excessive torque, and damage to disc and seat.

* When installing valve in a grooved-type piping system, consult piping manufacturer's specification to choose proper sealing surface. Installing valve without proper surface may cause damage to the valve seat or leakage at the valve.

3L Series Butterfly Valves - Applications

Bray Butterfly Valves for HVAC Applications

Bray is the largest butterfly valve manufacturer in the western hemisphere for a reason. Bray's in house design team and Bray owned ISO 9001 manufacturing facilities have over 30 years of experience with this product. Our track record of reliability in thousands of installations over time bear this out.

Bray Commercial Division offers two distinct lines of butterfly valves for HVAC applications. These low torque, high cycle life designs have emerged as the design standard in the commercial building market worldwide.

Comparative Valve Specifications		
	3L Series	MK Series
Design	Resilient Seated, Nylon Coated or Stainless Steel Disc	Double Offset, Pressure assisted, but not pressure dependent seat design. Stainless Steel Disc
Max. Close-Off Pressure	50 to 250 PSI	ANSI 150- 285 PSI ANSI 300- 740 PSI
Temperature Rating	-20° F to 250°F	-40° F to 500°F

Disclaimer - The performance specifications are nominal and conform to acceptable industry standards. For application at conditions beyond these specifications, consult the local Bray office. Bray, Inc. shall not be liable for damages resulting from misapplication or misuse of its products.



3L Series Butterfly Valves - 3-Way Configurations

Spring Return and Non-Spring Return

Configuration 1

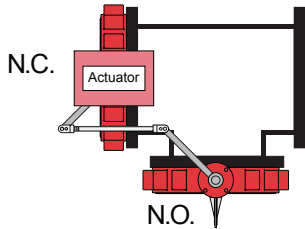

Configuration 2

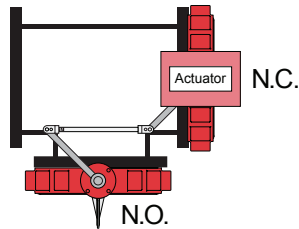

Configuration 3

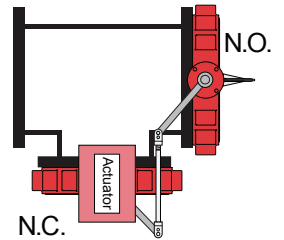

Configuration 4

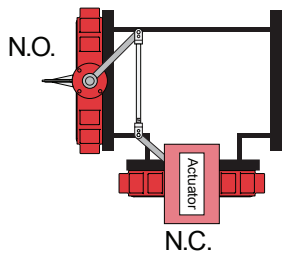

Configuration 5

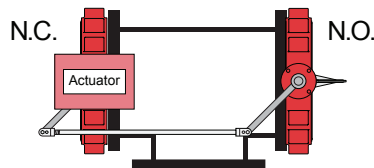

Configuration 6

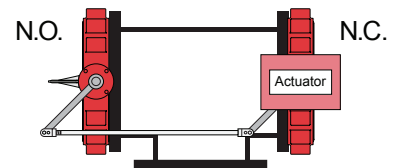

Configuration 7

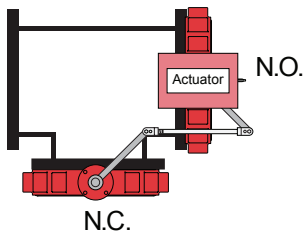

Configuration 8

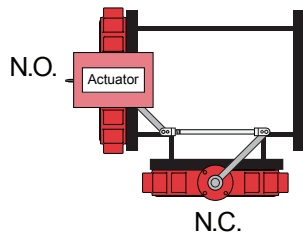

Configuration 9

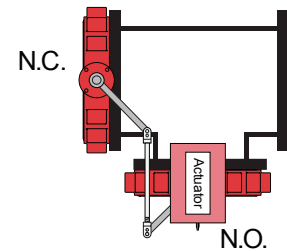

Configuration 10
(PN placeholder is 0)

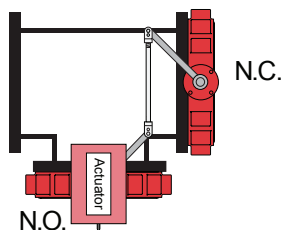

Note: All 3-Way butterfly valve assembly orders should have configuration specified. Pricing remains the same, however Bray must know the specifications in order to manufacture the appropriate linkage kit.

Note: 3-Way assemblies with low-pressure pneumatic actuators (D-Series) are limited to arrangements: 1, 2, 7, and 8.

Note: Unless otherwise requested valve will be shipped as illustrated by Configuration 3.

3L Series Butterfly Valves - Part Number Matrix

3 Series 3L Ductile Iron Body, 416 SS Stem, EPDM Seat											Valve Series		
L	Lug Body										Body Type		
W	Wafer Body										Body Type		
N	3LN Series - Nylon 11 coated										Disc Material		
S	3LS Series - 316 Stainless Steel										Disc Material		
E	EPDM (Ethylene Propylene Diene Monomer)										Seat Material		
-													
XX	Size (in.) 08=8", 12=12", etc.										Valve Size		
L	Low = 50 PSI										Close-Off Pressure		
S	Standard = 175/150 PSI												
H	High = 250 PSI												
2	2-Way										Valve Type		
3	3-Way												
C	2-way Assembly, Normally Closed										Configuration		
N	2-way Assembly, Normally Open												
X	For 3-Way only - (X= Configuration # - See page 3L-6)												
/													
70-xxxx	Series 70 Electric Actuators										Actuator		
71-xxxx	Series 71 Electric Actuators												
AU	Auma Actuators												
92-xxx	High Pressure Pneumatic, Double Acting												
93-xxx	High Pressure Pneumatic, Spring Return												
98-xxx	High Pressure Pneumatic, Spring Return												
D or DC	Commercial Electric Actuators												
D-3xxx	D3000 Series Low Pressure Pneumatic Actuators												
SV	Servo Card for 0-10 VDC or 4-20 mA modulation										Electric Actuator Accessories		
H	Anti-Condensation Heater												
BBU	Battery Back-Up Unit												
-S	120 VAC Solenoid Valve										Pneumatic Actuator Accessories		
-S4	24 VAC Solenoid Valve												
-SW	Valve Status Monitor for Pneumatic Actuator												
-C	1-Set Speed Controls for Solenoids												
-P	3-15 PSI Pneumatic Positioner												
-EP	4-20 mA Electro-Pneumatic Positioner												
-05	Dec clutchable Handwheel Manual Override												
3	L	N	E	-	12	S	2	C	/	70-E301	SVH	2" lugged butterfly valve, ductile iron body, standard pressure nylon coated disc, EPDM seat, 2-Way, normally closed with 3,000 in/lb 120V modulating actuator with heater.	Examples
3	L	N	E	-	06	L	3	5	/	70-24-0081		6" lugged butterfly valve, ductile iron body, undercut nylon coated disc, EPDM seat, three way configuration 5 with 800 in/lb 24V On/Off S70 actuator	

3L Series Butterfly Valves - Piping Geometry Charts

2-Way & 3-Way PIPING GEOMETRY CHART - Adjusted Cv at 60° Rotation

Valve Size	Model Number	Nominal Cv	Pipe Size																
			2"	2.5"	3"	4"	5"	6"	8"	10"	12"	14"	16"	18"	20"	22"	24"	26"	28"
2"	3L_E-02S**	66	66	64	62														
2.5"	3L_E-25S**	98		98	96	91													
3"	3L_E-03S**	171			171	162	153												
4"	3L_E-04X**	310				310	298	284											
5"	3L_E-05X**	470					470	457	425										
6"	3L_E-06X**	757						757	708	663									
8"	3L_E-08X**	1247							1247	1198	1140								
10"	3L_E-10X**	2005								2005	1944	1860							
12"	3L_E-12X**	2868									2868	2803	2700						
14"	3L_E-14X**	3328										3328	3285	3209					
16"	3L_E-16X**	4440											4440	4391	4301				
18"	3L_E-18X**	5509												5509	5461	5368			
20"	3L_E-20X**	7056													7056	7001	6889	6766	
24"	3L_E-24X**	10267															10267	10207	9124

** = (2C) 2-Way - Normally Closed
 (2N) 2-Way - Normally Open
 (3) 3-Way + Configuration Number (see pg. 3L-6)
 X or S = (L) Low Pressure or (S) Standard Pressure
 _ = (N) Nylon Coated Disc or (S) Stainless Steel Disc

2-Way & 3-Way PIPING GEOMETRY CHART - Adjusted Cv at 90° Rotation

Valve Size	Model Number	Nominal Cv	Pipe Size																
			2"	2.5"	3"	4"	5"	6"	8"	10"	12"	14"	16"	18"	20"	22"	24"	26"	28"
2"	3L_E-02S**	87	87	83	78														
2.5"	3L_E-25S**	185		185	173	149													
3"	3L_E-03S**	360			360	292	248												
4"	3L_E-04X**	740				740	611	509											
5"	3L_E-05X**	1218					1218	1039	773										
6"	3L_E-06X**	1900						1900	1379	1111									
8"	3L_E-08X**	3765							3765	2841	2250								
10"	3L_E-10X**	6661								6661	5112	3985							
12"	3L_E-12X**	10066									10066	8009	6271						
14"	3L_E-14X**	11598										11598	10079	8368					
16"	3L_E-16X**	15395											15395	13669	11507				
18"	3L_E-18X**	20120												20120	18108	15385	13431		
20"	3L_E-20X**	25329													25329	23088	19833	17369	
24"	3L_E-24X**	39396															39396	36382	31593

** = (2C) 2-Way - Normally Closed
 (2N) 2-Way - Normally Open
 (3) 3-Way + Configuration Number (see pg. 3L-6)
 X or S = (L) Low Pressure or (S) Standard Pressure
 _ = (N) Nylon Coated Disc or (S) Stainless Steel Disc

3L Series Butterfly Valves - Valve Dimensions

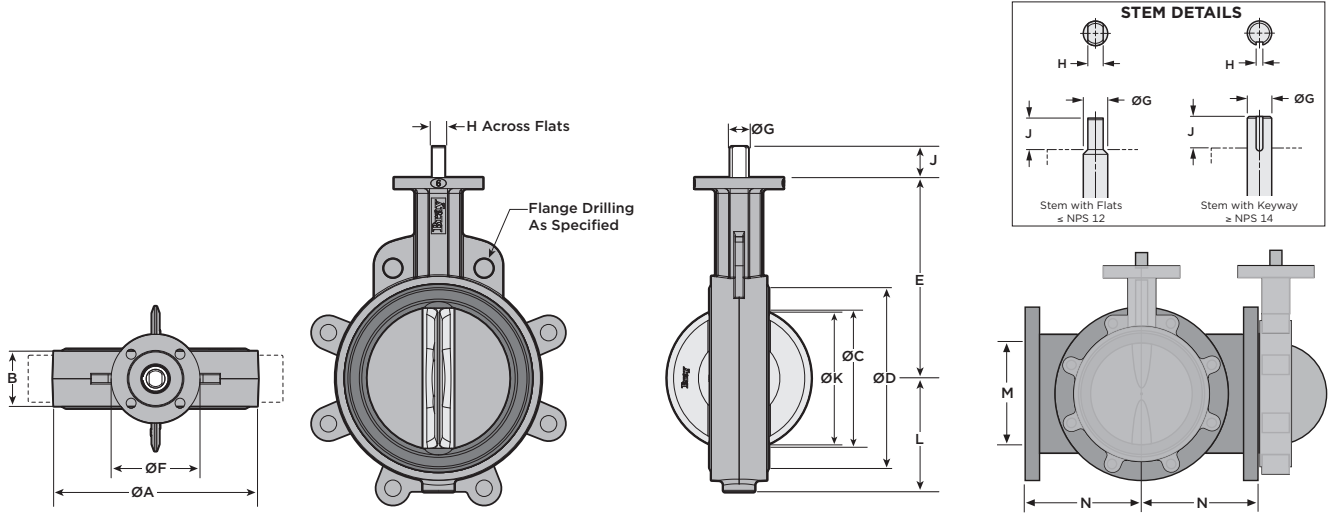

VALVE BODY DIMENSIONS in. (mm)

Valve Model Number	Size		A	B	C	D	E	F	G	H	J	K*	L	
	in.	mm											Wafer	Lug
3L_E-02S**	2	50	3.7 (94)	1.7 (43)	2.0 (51)	2.8 (71)	5.5 (140)	3.5 (90)	0.6 (14)	0.39 (10)	1.25 (32)	1.3 (32)	2.2 (56)	2.3 (58)
3L_E-25S**	2.5	65	4.3 (106)	1.8 (46)	2.5 (64)	3.3 (84)	6.0 (152)	3.5 (90)	0.6 (14)	0.39 (10)	1.25 (32)	1.9 (48)	2.5 (63)	2.6 (65)
3L_E-03S**	3	80	4.9 (124)	1.8 (46)	3.0 (76)	4.0 (100)	6.3 (159)	3.5 (90)	0.6 (14)	0.39 (10)	1.25 (32)	2.5 (64)	2.8 (71)	2.8 (71)
3L_E-04x**	4	100	6.1 (154)	2.1 (52)	4.1 (103)	5.1 (129)	7.0 (178)	3.5 (90)	0.6 (16)	0.43 (11)	1.25 (32)	3.6 (91)	3.4 (87)	4.1 (104)
3L_E-05x**	5	125	7.1 (179)	2.2 (56)	5.0 (128)	6.2 (157)	7.5 (191)	3.5 (90)	0.8 (19)	0.51 (13)	1.25 (32)	4.6 (117)	4.0 (102)	4.6 (117)
3L_E-06x**	6	150	8.1 (206)	2.2 (56)	5.8 (146)	7.1 (180)	8.0 (203)	3.5 (90)	0.8 (19)	0.51 (13)	1.25 (32)	5.4 (137)	4.5 (115)	5.1 (129)
3L_E-08x**	8	200	10.5 (267)	2.4 (60)	7.8 (197)	9.3 (237)	9.5 (241)	5.9 (150)	0.9 (22)	0.63 (16)	1.25 (32)	7.5 (190)	5.8 (146)	6.1 (154)
3L_E-10x**	10	250	12.6 (324)	2.7 (68)	9.8 (249)	11.4 (291)	10.8 (273)	5.9 (150)	1.2 (30)	0.87 (22)	2.0 (51)	9.5 (242)	7.1 (181)	7.7 (195)
3L_E-12x**	12	300	14.9 (373)	3.1 (78)	11.8 (299)	13.5 (342)	12.3 (311)	5.9 (150)	1.2 (30)	0.87 (22)	2.0 (51)	11.5 (291)	8.1 (206)	9.0 (229)
3L_E-14x**	14	350	17.1 (433)	3.1 (78)	13.3 (337)	15.3 (388)	13.6 (346)	5.9 (150)	1.4 (35)	.39x.39 (10x10)	2.0 (51)	13.0 (331)	9.4 (238)	9.9 (252)
3L_E-16x**	16	400	19.2 (488)	4.0 (102)	15.3 (387)	17.4 (442)	14.8 (375)	5.9 (150)	1.4 (35)	.39x.39 (10x10)	2.0 (51)	14.9 (377)	10.8 (273)	11.3 (287)
3L_E-18x**	18	450	21.1 (536)	4.5 (114)	17.3 (438)	19.5 (495)	16.0 (406)	8.3 (210)	2.0 (50)	.47x.39 (12x10)	2.5 (64)	16.8 (427)	12.0 (305)	12.2 (309)
3L_E-20x**	20	500	23.3 (591)	5.0 (127)	19.3 (489)	21.6 (548)	17.3 (438)	8.3 (210)	2.0 (50)	.47x.39 (12x10)	2.5 (64)	18.8 (476)	14.0 (356)	14.0 (356)
3L_E-24S**	24	600	28.2 (716)	6.1 (154)	23.3 (591)	25.6 (650)	19.5 (495)	8.3 (210)	2.5 (64)	.62x.62 (16x16)	4.0 (102)	22.7 (575)	17.6 (446)	17.6 (446)

VALVE BODY DIMENSIONS in. (mm) - Continued

Size		Top Plate Drilling			Lug Bolt Data			Tee		Adp. Code	Weight (lb)	
in.	mm	Bolt Circle	Hole Qty	Hole Dia.	BC	Holes	Threads	M	N		Wafer	Lug
2	50	2.8 (70)	4	0.4 (10)	4.8 (122)	4	5/8-11	2.0 (51)	4.5 (114)	A	6 (2.5)	7 (3)
2.5	65	2.8 (70)	4	0.4 (10)	5.5 (140)	4	5/8-11	2.5 (64)	5.0 (127)	A	7 (3)	8 (4)
3	80	2.8 (70)	4	0.4 (10)	6.0 (152)	4	5/8-11	3.0 (76)	5.5 (140)	A	8 (3.5)	9 (4)
4	100	2.8 (70)	4	0.4 (10)	7.5 (191)	8	5/8-11	4.0 (102)	6.5 (165)	B	12 (5.4)	16 (6)
5	125	2.8 (70)	4	0.4 (10)	8.5 (216)	8	3/4-10	5.0 (127)	7.5 (191)	C	15 (6.6)	21 (9)
6	150	2.8 (70)	4	0.4 (10)	9.5 (241)	8	3/4-10	6.0 (152)	8.0 (203)	C	19 (8.7)	25 (11)
8	200	4.9 (125)	4	0.6 (15)	11.8 (300)	8	3/4-10	8.0 (203)	9.0 (229)	D	34 (15.3)	40 (18)
10	250	4.9 (125)	4	0.6 (15)	14.3 (363)	12	7/8-9	10.0 (254)	11.0 (279)	E	51 (23)	62 (26)
12	300	4.9 (125)	4	0.6 (15)	17.0 (432)	12	7/8-9	12.0 (305)	12.0 (305)	E	68 (31)	91 (41)
14	350	4.9 (125)	4	0.6 (15)	18.8 (478)	12	1-8	14.0 (356)	14.0 (356)	F	105 (48)	122 (55)
16	400	4.9 (125)	4	0.6 (15)	21.3 (541)	16	1-8	16.0 (406)	15.0 (381)	F	150 (68)	166 (75)
18	450	6.5 (165)	4	0.8 (21)	22.8 (579)	16	1-1/8-8	18.0 (457)	16.5 (419)	G	212 (96)	233 (106)
20	500	6.5 (165)	4	0.8 (21)	25.0 (635)	20	1-1/8-8	20.0 (508)	18.0 (457)	G	285 (129)	340 (154)
24	600	6.5 (165)	4	0.8 (21)	29.5 (749)	20	1-1/4-8	-	-	H	410 (186)	490 (222)

3L Series Butterfly Valves - Actuator Dimensions

COMMERCIAL ACTUATOR DIMENSIONS in. (mm)

Actuator Model Number	L	M	N	Weight lbs. (kg)
DCS-140 Series	7.4 (188)	11.0 (279)	4.0 (102)	4.9 (2.2)
DC-310 Series	7.4 (188)	11.0 (279)	4.0 (102)	4.4 (2.0)
D-140/210 Series	6.7 (170)	7.5 (191)	4.0 (102)	2.9 (1.3)
DS-180 Series	7.4 (188)	11.0 (279)	4.0 (102)	6.4 (2.9)
Tandem Actuators	11.8 (300)	18.0 (457)	4.0 (102)	12.8 (5.8)

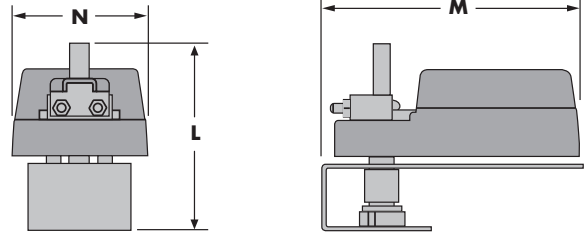

INDUSTRIAL ACTUATOR DIMENSIONS in. (mm)

Actuator Model Number	A	B	D*		Weight lbs. (kg)
			2-Way	3-Way	
70-0081	7.5 (191)	5.8 (147)	5.6 (141)	8.6 (218)	13 (6)
70-0121/0201/E301	10.1 (256)	7.8 (198)	6.6 (168)	10.7 (273)	28 (13)
70-0501/0651	12.1 (308)	9.5 (241)	7.2 (183)	13.2 (335)	48 (22)
70-1300/1800	12.1 (308)	9.5 (241)	12.5 (316)	20.5 (521)	118 (54)
AU-4068	32.1 (815)	28.9 (734)	12.3 (312)	22.3 (566)	195 (88)
AU-7080	32.1 (815)	31.9 (810)	12.3 (312)	-	285 (129)

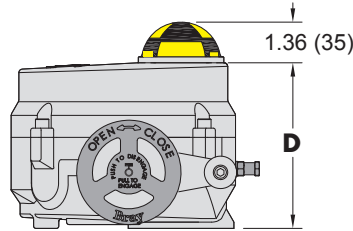
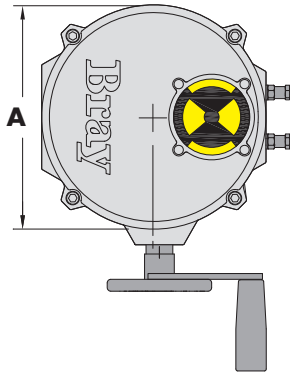

ALLOW 4.0 (102)
FOR COVER REMOVAL

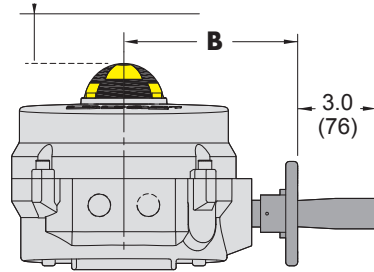

LP PNEUMATIC ACTUATOR DIMENSIONS in. (mm)

Low Pressure Pneumatic Actuator Model Number	J	L	N		Weight lbs. (kg)
			2-Way	3-Way	
D-3153	13.8 (351)	5.7 (145)	16.0 (406)	10.9 (277)	8.0 (3.6)
D-3244	14.4 (366)	7.3 (185)	20.0 (508)	12.0 (305)	13.6 (6.2)
D-3246	16.4 (417)	8.9 (226)	25.8 (655)	13.7 (348)	17.6 (8.0)
D-3246-D	17.6 (447)	8.9 (226)	22.8 (579)	24.00 (610)	35.1 (15.9)

Largest valve/actuator combination shown

L = Maximum swing of the actuator

N = Maximum swing of the arm

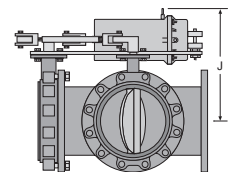
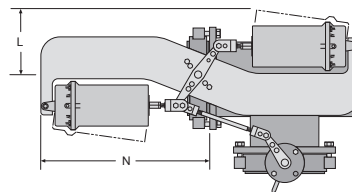
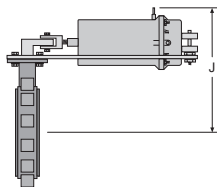
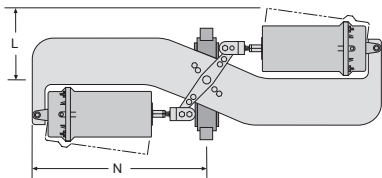

3L Series Butterfly Valves - Actuator Dimensions

PNEUMATIC ACTUATOR DIMENSIONS in. (mm)

Actuator Model Number	L	M	N	F	G	H	Weight lbs. (kg)	
							Double Acting	Spring Return
92/93-063	3.1 (79)	5.6 (142)	4.5 (114)	7.5 (191)	3.0 (76)	9.1 (231)	3.4 (1.5)	4.1 (1.9)
92/93-083	4.1 (104)	7.4 (188)	5.4 (137)	8.4 (213)	4.5 (114)	13.3 (338)	6.3 (3)	8.1 (4)
92/93-093	4.4 (112)	9.1 (231)	5.8 (147)	8.8 (224)	5.5 (140)	14.9 (378)	8.5 (4)	10.8 (5)
92/93-119	5.2 (132)	12.4 (325)	7.3 (185)	11.4 (290)	8.0 (203)	19.9 (505)	16.9 (8)	22.3 (10)
92/93-128	5.6 (142)	12.8 (734)	8.1 (2.6)	12.2 (310)	8.0 (203)	19.9 (505)	21.0 (10)	27.6 (13)
92/93-160	7.2 (183)	15.5 (394)	9.4 (239)	13.5 (343)	10.5 (267)	26.6 (676)	38.8 (18)	53.2 (24)
92/93-210	9.0 (229)	19.6 (498)	11.6 (295)	17.6 (447)	13.8 (351)	33.1 (841)	77.8 (35)	109.6 (50)
92/93-255	10.8 (274)	28.8 (732)	13.5 (343)	19.5 (495)	13.8 (351)	33.1 (841)	167.0 (76)	210.8 (96)
98-45E2-...	14.8 (376)	52.8 (1341)	9.7 (246)	-	-	-	183 (83)	355 (161)
98-14E3-...	21.3 (541)	72.6 (1844)	12.1 (307)	-	-	-	485 (220)	937 (425)
98-73E2-...	16.8 (427)	60.1 (1527)	11.8 (300)	-	-	-	254 (115)	547 (248)

Allow 3.0" for Series 92/93 actuator removal and up to 12" for Series 98

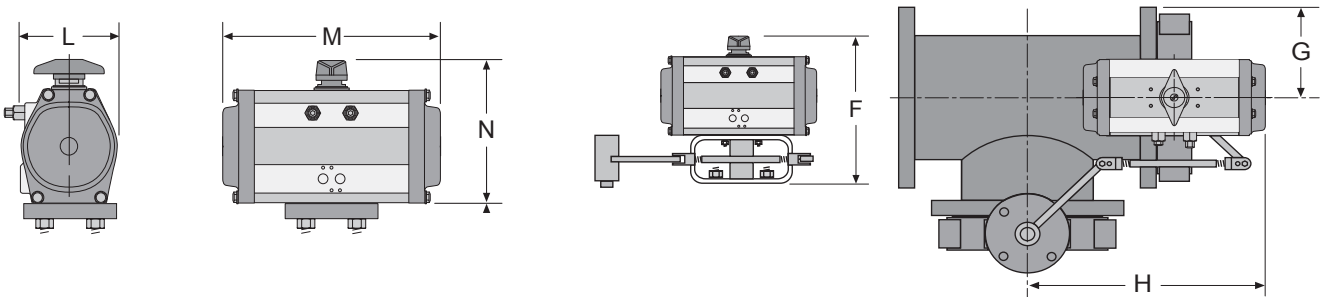

VP200 Pneumatic Positioner

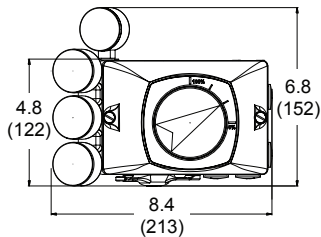

Series 5A Switch Box

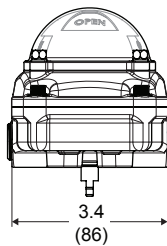

Series 6A Electro Pneumatic Positioner

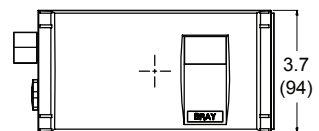
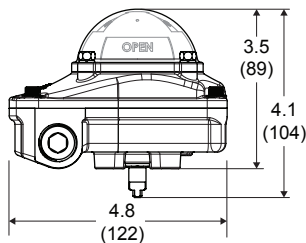
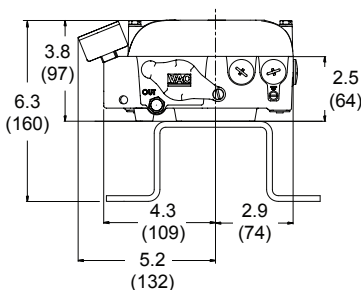
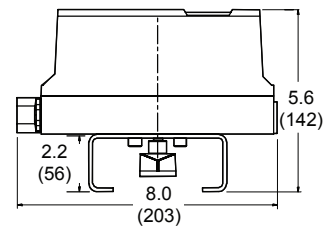

3L Series Butterfly Valves - Close-Off Charts

2-Way with NSR/SR DC-Series Commercial Electric Actuators

Nylon Coated Disc

2-Way, On/Off & Floating - Nylon Coated Disc											
Actuator Model Details						Non-Spring Return		Spring Return			
						DC24-310-T	DC24-310-T-D	DCS24-140	DCS24-140-D	DCS120-140	DCS120-140-D
Model Number	Size		Close-Off PSI	Cv		Floating		On/Off			
	In.	mm		90°	60°	24 VAC		24 VAC/DC		120 VAC	
3LNE-02S2C	2	50	175	87	66	X	-	X	-	X	-
3LNE-25S2C	2.5	65	175	185	98	X	-	X	-	X	-
3LNE-03S2C	3	80	175	360	171	X	-	-	X	-	X
3LNE-04L2C	4	100	50	740	310	X	-	X	-	X	-
3LNE-04S2C	4	100	175	740	310	X	-	-	X	-	X
3LNE-05L2C	5	125	50	1218	470	X	-	-	X	-	X
3LNE-06L2C	6	150	50	1900	757	-	X	-	-	-	-

2-Way, Modulating - Nylon Coated Disc									
Actuator Model Details						Non-Spring Return		Spring Return	
						DCM24-310	DCM24-310-D	DCMS24-140	DCMS24-140-D
Model Number	Size		Close-Off PSI	Cv		Modulating			
	In.	mm		90°	60°	24 VAC		24 VAC/DC	
3LNE-02S2C	2	50	175	87	66	X	-	X	-
3LNE-25S2C	2.5	65	175	185	98	X	-	X	-
3LNE-03S2C	3	80	175	360	171	X	-	-	X
3LNE-04L2C	4	100	50	740	310	X	-	X	-
3LNE-04S2C	4	100	175	740	310	X	-	-	X
3LNE-05L2C	5	125	50	1218	470	X	-	-	X
3LNE-06L2C	6	150	50	1900	757	-	X	-	-

Stainless Steel Disc

2-Way, On/Off & Floating - Stainless Steel Disc											
Actuator Model Details						Non-Spring Return		Spring Return			
						DC24-310-T	DC24-310-T-D	DCS24-140	DCS24-140-D	DCS120-140	DCS120-140-D
Model Number	Size		Close-Off PSI	Cv		Floating		On/Off			
	In.	mm		90°	60°	24 VAC		24 VAC/DC		120 VAC	
3LSE-02S2C	2	50	175	87	66	X	-	X	-	X	-
3LSE-25S2C	2.5	65	175	185	98	X	-	X	-	X	-
3LSE-03S2C	3	80	175	360	171	X	-	-	X	-	X
3LSE-04L2C	4	100	50	740	310	X	-	-	X	-	X
3LSE-04S2C	4	100	175	740	310	X	-	-	X	-	X
3LSE-05L2C	5	125	50	1218	470	X	-	-	X	-	X
3LSE-06L2C	6	150	50	1900	757	-	X	-	-	-	-

2-Way, Modulating - Stainless Steel Disc									
Actuator Model Details						Non-Spring Return		Spring Return	
						DCM24-310	DCM24-310-D	DCMS24-140	DCMS24-140-D
Model Number	Size		Close-Off PSI	Cv		Modulating			
	In.	mm		90°	60°	24 VAC		24 VAC/DC	
3LSE-02S2C	2	50	175	87	66	X	-	X	-
3LSE-25S2C	2.5	65	175	185	98	X	-	X	-
3LSE-03S2C	3	80	175	360	171	X	-	-	X
3LSE-04L2C	4	100	50	740	310	X	-	-	X
3LSE-04S2C	4	100	175	740	310	X	-	-	X
3LSE-05L2C	5	125	50	1218	470	X	-	-	X
3LSE-06L2C	6	150	50	1900	757	-	X	-	-

Options/Addrs
 For optional auxiliary switches, add -A to the end of the actuator part number.
 For Spring Return Units:
 N = Normally Open
 C = Normally Closed - Factory default
 -D = Dual mounted actuators

3L Series Butterfly Valves - Close-Off Charts

3-Way with NSR/SR DC-Series Commercial Electric Actuators

Nylon Coated Disc

Actuator Model Details						Non-Spring Return		Spring Return			
						DC24-310-T	DC24-310-T-D	DCS24-140	DCS24-140-D	DCS120-140	DCS120-140-D
Valve Model Details	Size		Close-Off PSI	Cv		Floating		On/Off			
	In.	mm		90°	60°	24 VAC		24 VAC/DC		120 VAC	
3LNE-02S3X	2	50	175	87	66	X	-	X	-	X	-
3LNE-25S3X	2.5	65	175	185	98	X	-	-	X	-	X
3LNE-03S3X	3	80	175	360	171	X	-	-	X	-	X
3LNE-04L3X	4	100	50	740	310	X	-	-	X	-	X
3LNE-04S3X	4	100	175	740	310	-	X	-	-	-	-
3LNE-05L3X	5	125	50	1218	470	X	-	-	X	-	X
3LNE-06L3X	6	150	50	1900	757	-	X	-	-	-	-

Actuator Model Details						Non-Spring Return		Spring Return	
						DCM24-310	DCM24-310-D	DCMS24-140	DCMS24-140-D
Valve Model Details	Size		Close-Off PSI	Cv		Modulating			
	In.	mm		90°	60°	24 VAC		24 VAC/DC	
3LNE-02S3X	2	50	175	87	66	X	-	X	-
3LNE-25S3X	2.5	65	175	185	98	X	-	-	X
3LNE-03S3X	3	80	175	360	171	X	-	-	X
3LNE-04L3X	4	100	50	740	310	X	-	-	X
3LNE-04S3X	4	100	175	740	310	-	X	-	-
3LNE-05L3X	5	125	50	1218	470	X	-	-	X
3LNE-06L3X	6	150	50	1900	757	-	X	-	-

Stainless Steel Disc

Actuator Model Details						Non-Spring Return		Spring Return			
						DC24-310-T	DC24-310-T-D	DCS24-140	DCS24-140-D	DCS120-140	DCS120-140-D
Valve Model Details	Size		Close-Off PSI	Cv		Floating		On/Off			
	In.	mm		90°	60°	24 VAC		24 VAC/DC		120 VAC	
3LSE-02S3X	2	50	175	87	66	X	-	X	-	X	-
3LSE-25S3X	2.5	65	175	185	98	X	-	-	X	-	X
3LSE-03S3X	3	80	175	360	171	X	-	-	X	-	X
3LSE-04L3X	4	100	50	740	310	X	-	-	X	-	X
3LSE-04S3X	4	100	175	740	310	-	X	-	-	-	-
3LSE-05L3X	5	125	50	1218	470	-	X	-	X	-	X
3LSE-06L3X	6	150	50	1900	757	-	X	-	-	-	-

Actuator Model Details						Non-Spring Return		Spring Return	
						DCM24-310	DCM24-310-D	DCMS24-140	DCMS24-140-D
Valve Model Details	Size		Close-Off PSI	Cv		Modulating			
	In.	mm		90°	60°	24 VAC		24 VAC/DC	
3LSE-02S3X	2	50	175	87	66	X	-	X	-
3LSE-25S3X	2.5	65	175	185	98	X	-	-	X
3LSE-03S3X	3	80	175	360	171	X	-	-	X
3LSE-04L3X	4	100	50	740	310	X	-	-	X
3LSE-04S3X	4	100	175	740	310	-	X	-	-
3LNE-05L3X	5	125	50	1218	470	-	X	-	X
3LSE-06L3X	6	150	50	1900	757	-	X	-	-

Options/Adders
 For optional auxiliary switches, add -A to the end of the actuator part number.
 X = 3-Way Assemblies (Refer to Configuration Chart, Page 6)
 -D = Dual mounted actuators

3L Series Butterfly Valves - Close-Off Charts

2-Way with NSR/SR D-Series Commercial Electric Actuators

Nylon Coated Disc

2-Way, On/Off or Floating - Nylon Coated Disc						Non-Spring Return			Spring Return	
Actuator Model Details						D24-140	D24-210	D24-210-D	DS24-180	DS24-180-D
Valve Model Details	Size		Close-Off PSI	Cv		On/Off & Floating			On/Off	
	In.	mm		90°	60°	24 VAC/DC			24 VAC/DC	
3LNE-02S2C	2	50	175	87	66	X	-	-	X	-
3LNE-25S2C	2.5	65	175	185	98	X	-	-	X	-
3LNE-03S2C	3	80	175	360	171	-	X	-	X	-
3LNE-04L2C	4	100	50	740	310	-	X	-	X	-
3LNE-04S2C	4	100	175	740	310	-	-	X	-	X
3LNE-05L2C	5	125	50	1218	470	-	X	-	-	X
3LNE-05S2C	5	125	175	1218	470	-	-	X	-	-
3LNE-06L2C	6	150	50	1900	757	-	-	X	-	X

2-Way, Modulating - Nylon Coated Disc						Non-Spring Return			Spring Return	
Actuator Model Details						DM24-140	DM24-210	DM24-210-D	DMS24-180	DMS24-180-D
Valve Model Details	Size		Close-Off PSI	Cv		Modulating				
	In.	mm		90°	60°	24 VAC/DC			24 VAC/DC	
3LNE-02S2C	2	50	175	87	66	X	-	-	X	-
3LNE-25S2C	2.5	65	175	185	98	X	-	-	X	-
3LNE-03S2C	3	80	175	360	171	-	X	-	X	-
3LNE-04L2C	4	100	50	740	310	-	X	-	X	-
3LNE-04S2C	4	100	175	740	310	-	-	X	-	X
3LNE-05L2C	5	125	50	1218	470	-	X	-	-	X
3LNE-05S2C	5	125	175	1218	470	-	-	X	-	-
3LNE-06L2C	6	150	50	1900	757	-	-	X	-	X

Stainless Steel Disc

2-Way, On/Off or Floating - Stainless Steel Disc						Non-Spring Return			Spring Return	
Actuator Model Details						D24-140	D24-210	D24-210-D	DS24-180	DS24-180-D
Valve Model Details	Size		Close-Off PSI	Cv		On/Off & Floating			On/Off	
	In.	mm		90°	60°	24 VAC/DC			24 VAC/DC	
3LSE-02S2C	2	50	175	87	66	X	-	-	X	-
3LSE-25S2C	2.5	65	175	185	98	-	X	-	X	-
3LSE-03S2C	3	80	175	360	171	-	X	-	X	-
3LSE-04L2C	4	100	50	740	310	-	X	-	X	-
3LSE-04S2C	4	100	175	740	310	-	-	X	-	X
3LSE-05L2C	5	125	50	1218	470	-	X	-	-	X
3LSE-05S2C	5	125	175	1218	470	-	-	X	-	-
3LSE-06L2C	6	150	50	1900	757	-	-	X	-	-

2-Way, Modulating - Stainless Steel Disc						Non-Spring Return			Spring Return	
Actuator Model Details						DM24-140	DM24-210	DM24-210-D	DMS24-180	DMS24-180-D
Valve Model Details	Size		Close-Off PSI	Cv		Modulating				
	In.	mm		90°	60°	24 VAC/DC			24 VAC/DC	
3LSE-02S2C	2	50	175	87	66	X	-	-	X	-
3LSE-25S2C	2.5	65	175	185	98	-	X	-	X	-
3LSE-03S2C	3	80	175	360	171	-	X	-	X	-
3LSE-04L2C	4	100	50	740	310	-	X	-	X	-
3LSE-04S2C	4	100	175	740	310	-	-	X	-	X
3LSE-05L2C	5	125	50	1218	470	-	X	-	-	X
3LSE-05S2C	5	125	175	1218	470	-	-	X	-	-
3LSE-06L2C	6	150	50	1900	757	-	-	X	-	-

Options/Adders
 For optional auxiliary switches, add -A to the end of the actuator part number.
 For Spring Return Units:
 N = Normally Open
 C = Normally Closed - Factory default
 -D = Dual mounted actuators

3L Series Butterfly Valves - Close-Off Charts

3-Way with NSR/SR Series with D-Series Commercial Electric Actuators

Nylon Coated Disc

3-Way, On/Off or Floating - Nylon Coated Disc						Non-Spring Return			Spring Return	
Actuator Model Details						D24-140	D24-210	D24-210-D	DS24-180	DS24-180-D
Valve Model Details	Size		Close-Off PSI	Cv		On/Off & Floating			On/Off	
	In.	mm		90°	60°	24 VAC/DC			24 VAC/DC	
3LNE-02S3X	2	50	175	87	66	X	-	-	X	-
3LNE-25S3X	2.5	65	175	185	98	-	X	-	X	-
3LNE-03S3X	3	80	175	360	171	-	X	-	-	X
3LNE-04L3X	4	100	50	740	310	-	X	-	-	X
3LNE-04S3X	4	100	175	740	310	-	-	X	-	X
3LNE-05L3X	5	125	50	1218	470	-	-	X	-	X
3LNE-06L3X	6	150	50	1900	757	-	-	X	-	-

3-Way, Modulating - Nylon Coated Disc						Non-Spring Return			Spring Return	
Actuator Model Details						DM24-140	DM24-210	DM24-210-D	DMS24-180	DMS24-180-D
Valve Model Details	Size		Close-Off PSI	Cv		Modulating				
	In.	mm		90°	60°	24 VAC/DC			24 VAC/DC	
3LNE-02S3X	2	50	175	87	66	X	-	-	X	-
3LNE-25S3X	2.5	65	175	185	98	-	X	-	X	-
3LNE-03S3X	3	80	175	360	171	-	X	-	-	X
3LNE-04L3X	4	100	50	740	310	-	X	-	-	X
3LNE-04S3X	4	100	175	740	310	-	-	X	-	X
3LNE-05L3X	5	125	50	1218	470	-	-	X	-	X
3LNE-06L3X	6	150	50	1900	757	-	-	X	-	-

Stainless Steel Disc

3-Way, On/Off or Floating - Stainless Steel Disc						Non-Spring Return		Spring Return		
Actuator Model Details						D24-210	D24-210-D	DS24-180	DS24-180-D	
Valve Model Details	Size		Close-Off PSI	Cv		On/Off & Floating			On/Off	
	In.	mm		90°	60°	24 VAC/DC			24 VAC/DC	
3LSE-02S3X	2	50	175	87	66	X	-	X	-	
3LSE-25S3X	2.5	65	175	185	98	X	-	X	-	
3LSE-03S3X	3	80	175	360	171	-	X	-	X	
3LSE-04L3X	4	100	50	740	310	X	-	-	X	
3LSE-04S3X	4	100	175	740	310	-	X	-	-	
3LSE-05L3X	5	125	50	1218	470	-	X	-	X	

3-Way, Modulating - Stainless Steel Disc						Non-Spring Return		Spring Return		
Actuator Model Details						DM24-210	DM24-210-D	DMS24-180	DMS24-180-D	
Valve Model Details	Size		Close-Off PSI	Cv		Modulating				
	In.	mm		90°	60°	24 VAC/DC			24 VAC/DC	
3LSE-02S3X	2	50	175	87	66	X	-	X	-	
3LSE-25S3X	2.5	65	175	185	98	X	-	X	-	
3LSE-03S3X	3	80	175	360	171	-	X	-	X	
3LSE-04L3X	4	100	50	740	310	X	-	-	X	
3LSE-04S3X	4	100	175	740	310	-	X	-	-	
3LSE-05L3X	5	125	50	1218	470	-	X	-	X	

Options/Adders
 For optional auxiliary switches, add -A to the end of the actuator part number.
 X = 3-Way Assemblies (Refer to Configuration Chart, Page 6)
 -D = Dual mounted actuators

3L Series Butterfly Valves - Close-Off Charts

2-Way with Industrial Electric Actuators

Nylon Coated Disc

2-Way, 24 VAC and 120 VAC, On/Off & Modulating - Nylon Coated Disc									
Valve Model Details	Actuator Model Details					Series 70 & AU Series		Series 70	
	Size		Close-Off PSI	Cv		On/Off	Modulating	On/Off	Modulating
	In.	mm		90°	60°	120 VAC	120 VAC	24 VAC	24 VAC
3LNE-02S2C	2	50	175	87	66	70-0081	70-0081SV	70-24-0081	70-24-0081SV
3LNE-25S2C	2.5	65	175	185	98	70-0081	70-0081SV	70-24-0081	70-24-0081SV
3LNE-03S2C	3	80	175	360	171	70-0081	70-0081SV	70-24-0081	70-24-0081SV
3LNE-04L2C	4	100	50	740	310	70-0081	70-0081SV	70-24-0081	70-24-0081SV
3LNE-04S2C	4	100	175	740	310	70-0081	70-0081SV	70-24-0081	70-24-0081SV
3LNE-05L2C	5	125	50	1218	470	70-0081	70-0081SV	70-24-0081	70-24-0081SV
3LNE-05S2C	5	125	175	1218	470	70-0081	70-0081SV	70-24-0081	70-24-0081SV
3LNE-06L2C	6	150	50	1900	757	70-0081	70-0081SV	70-24-0081	70-24-0081SV
3LNE-06S2C	6	150	175	1900	757	70-0081	70-0081SV	70-24-0081	70-24-0081SV
3LNE-08L2C	8	200	50	3765	1247	70-0121	70-0121SV	70-24-0201	70-24-0201SV
3LNE-08S2C	8	200	175	3765	1247	70-0121	70-0121SV	70-24-0201	70-24-0201SV
3LNE-10L2C	10	250	50	6661	2005	70-0121	70-0121SV	70-24-0201	70-24-0201SV
3LNE-10S2C	10	250	175	6661	2005	70-0201	70-0201SV	70-24-0201	70-24-0201SV
3LNE-12L2C	12	300	50	10066	2868	70-0201	70-0201SV	70-24-0201	70-24-0201SV
3LNE-12S2C	12	300	175	10066	2868	70-E301	70-E301SV	70-24-E301	70-24-E301SV
3LNE-14L2C	14	350	50	11598	3328	70-0501	70-0501SV	70-24-0501	70-24-0501SV
3LNE-14S2C	14	350	150	11598	3328	70-0501	70-0501SV	70-24-0501	70-24-0501SV
3LNE-16L2C	16	400	50	15395	4440	70-0501	70-0501SV	70-24-0501	70-24-0501SV
3LNE-16S2C	16	400	150	15395	4440	70-0651	70-0651SV	-	-
3LNE-18L2C	18	450	50	20120	5509	70-0651	70-0651SV	-	-
3LNE-18S2C	18	450	150	20120	5509	70-1300	70-1300SV	-	-
3LNE-20L2C	20	500	50	25329	7056	70-1300	70-1300SV	-	-
3LNE-20S2C	20	500	150	25329	7056	70-1800	70-1800SV	-	-
3LNE-24L2C	24	600	50	39396	10267	70-1800	70-1800SV	-	-
3LNE-24S2C	24	600	150	39396	10267	AU-4068	AU-4068SV	-	-
NYF2-C301	30	750	75	52443	18090	AU-4068	AU-4068SV	-	-
NYF2-C300	30	750	150	52443	18090	AU-7080	AU-7080SV	-	-

Stainless Steel Disc

2-Way, 24 VAC and 120 VAC, On/Off & Modulating - Stainless Steel Disc									
Valve Model Details	Actuator Model Details					Series 70 & AU Series		Series 70	
	Size		Close-Off PSI	Cv		On/Off	Modulating	On/Off	Modulating
	In.	mm		90°	60°	120 VAC	120 VAC	24 VAC	24 VAC
3LSE-02S2C	2	50	175	87	66	70-0081	70-0081SV	70-24-0081	70-24-0081SV
3LSE-25S2C	2.5	65	175	185	98	70-0081	70-0081SV	70-24-0081	70-24-0081SV
3LSE-03S2C	3	80	175	360	171	70-0081	70-0081SV	70-24-0081	70-24-0081SV
3LSE-04L2C	4	100	50	740	310	70-0081	70-0081SV	70-24-0081	70-24-0081SV
3LSE-04S2C	4	100	175	740	310	70-0081	70-0081SV	70-24-0081	70-24-0081SV
3LSE-05L2C	5	125	50	1218	470	70-0081	70-0081SV	70-24-0081	70-24-0081SV
3LSE-05S2C	5	125	175	1218	470	70-0081	70-0081SV	70-24-0081	70-24-0081SV
3LSE-06L2C	6	150	50	1900	757	70-0081	70-0081SV	70-24-0081	70-24-0081SV
3LSE-06S2C	6	150	175	1900	757	70-0081	70-0081SV	70-24-0081	70-24-0081SV
3LSE-08L2C	8	200	50	3765	1247	70-0121	70-0121SV	70-24-0201	70-24-0201SV
3LSE-08S2C	8	200	175	3765	1247	70-0201	70-0201SV	70-24-0201	70-24-0201SV
3LSE-10L2C	10	250	50	6661	2005	70-0121	70-0121SV	70-24-0201	70-24-0201SV
3LSE-10S2C	10	250	175	6661	2005	70-0201	70-0201SV	70-24-0201	70-24-0201SV
3LSE-12L2C	12	300	50	10066	2868	70-0201	70-0201SV	70-24-0201	70-24-0201SV
3LSE-12S2C	12	300	175	10066	2868	70-E301	70-E301SV	70-24-E301	70-24-E301SV
3LSE-14S2C	14	350	150	11598	3328	70-0501	70-0501SV	70-24-0501	70-24-0501SV
3LSE-16S2C	16	400	150	15395	4440	70-1300	70-1300SV	-	-
3LSE-18S2C	18	450	150	20120	5509	70-1300	70-1300SV	-	-
3LSE-20S2C	20	500	150	25329	7056	70-1800	70-1800SV	-	-
3LSE-24S2C	24	600	150	39396	10267	AU-4068	AU-4068SV	-	-

Options/Addrs
 For Heater/Thermostat kit, add "H" to the actuator part number.
 For Battery Back-Up Failsafe Option (BBU) option on 24 VAC actuators, add "-BBU".
 For Spring Return Units:
 N = Normally Open
 C = Normally Closed - Factory default

3L Series Butterfly Valves - Close-Off Charts

3-Way with Industrial Electric Actuators

Nylon Coated Disc

3-Way, 24 VAC and 120 VAC, On/Off & Modulating - Nylon Coated Disc									
Valve Model Details	Actuator Model Details					Series 70 & AU Series		Series 70	
	Size		Close-Off PSI	Cv		On/Off	Modulating	On/Off	Modulating
	In.	mm		90°	60°	120 VAC	120 VAC	24 VAC	24 VAC
3LNE-02S3X	2	50	175	87	66	70-0081	70-0081SV	70-24-0081	70-24-0081SV
3LNE-25S3X	2.5	65	175	185	98	70-0081	70-0081SV	70-24-0081	70-24-0081SV
3LNE-03S3X	3	80	175	360	171	70-0081	70-0081SV	70-24-0081	70-24-0081SV
3LNE-04L3X	4	100	50	740	310	70-0081	70-0081SV	70-24-0081	70-24-0081SV
3LNE-04S3X	4	100	175	740	310	70-0081	70-0081SV	70-24-0081	70-24-0081SV
3LNE-05L3X	5	125	50	1218	470	70-0081	70-0081SV	70-24-0081	70-24-0081SV
3LNE-05S3X	5	125	175	1218	470	70-0081	70-0081SV	70-24-0081	70-24-0081SV
3LNE-06L3X	6	150	50	1900	757	70-0081	70-0081SV	70-24-0081	70-24-0081SV
3LNE-06S3X	6	150	175	1900	757	70-0081	70-0081SV	70-24-0081	70-24-0081SV
3LNE-08L3X	8	200	50	3765	1247	70-0121	70-0121SV	70-24-0201	70-24-0201SV
3LNE-08S3X	8	200	175	3765	1247	70-0201	70-0201SV	70-24-0201	70-24-0201SV
3LNE-10L3X	10	250	50	6661	2005	70-0201	70-0201SV	70-24-0201	70-24-0201SV
3LNE-10S3X	10	250	175	6661	2005	70-E301	70-E301SV	70-24-E301	70-24-E301SV
3LNE-12L3X	12	300	50	10066	2868	70-0201	70-0201SV	70-24-0201	70-24-0201SV
3LNE-12S3X	12	300	175	10066	2868	70-0501	70-0501SV	70-24-0501	70-24-0501SV
3LNE-14L3X	14	350	50	11598	3328	70-0501	70-0501SV	70-24-0501	70-24-0501SV
3LNE-14S3X	14	350	150	11598	3328	70-0651	70-0651SV	-	-
3LNE-16L3X	16	400	50	15395	4440	70-0651	70-0651SV	-	-
3LNE-16S3X	16	400	150	15395	4440	70-1300	70-1300SV	-	-
3LNE-18L3X	18	450	50	20120	5509	70-1300	70-1300SV	-	-
3LNE-18S3X	18	450	150	20120	5509	70-1800	70-1800SV	-	-
3LNE-20L3X	20	500	50	25329	7056	70-1800	70-1800SV	-	-
3LNE-20S3X	20	500	150	25329	7056	AU-4068	AU-4068SV	-	-

Stainless Steel Disc

3-Way, 24 VAC and 120 VAC, On/Off & Modulating - Stainless Steel Disc									
Valve Model Details	Actuator Model Details					Series 70 & AU Series		Series 70	
	Size		Close-Off PSI	Cv		On/Off	Modulating	On/Off	Modulating
	In.	mm		90°	60°	120 VAC	120 VAC	24 VAC	24 VAC
3LSE-02S3X	2	50	175	87	66	70-0081	70-0081SV	70-24-0081	70-24-0081SV
3LSE-25S3X	2.5	65	175	185	98	70-0081	70-0081SV	70-24-0081	70-24-0081SV
3LSE-03S3X	3	80	175	360	171	70-0081	70-0081SV	70-24-0081	70-24-0081SV
3LSE-04L3X	4	100	50	740	310	70-0081	70-0081SV	70-24-0081	70-24-0081SV
3LSE-04S3X	4	100	175	740	310	70-0081	70-0081SV	70-24-0081	70-24-0081SV
3LSE-05L3X	5	125	50	1218	470	70-0081	70-0081SV	70-24-0081	70-24-0081SV
3LSE-05S3X	5	125	175	1218	470	70-0081	70-0081SV	70-24-0081	70-24-0081SV
3LSE-06L3X	6	150	50	1900	757	70-0081	70-0081SV	70-24-0081	70-24-0081SV
3LSE-06S3X	6	150	175	1900	757	70-0081	70-0081SV	70-24-0081	70-24-0081SV
3LSE-08L3X	8	200	50	3765	1247	70-0121	70-0121SV	70-24-0201	70-24-0201SV
3LSE-08S3X	8	200	175	3765	1247	70-0201	70-0201SV	70-24-0201	70-24-0201SV
3LSE-10L3X	10	250	50	6661	2005	70-0201	70-0201SV	70-24-0201	70-24-0201SV
3LSE-10S3X	10	250	175	6661	2005	70-E301	70-E301SV	70-24-E301	70-24-E301SV
3LSE-12L3X	12	300	50	10066	2868	70-E301	70-E301SV	70-24-E301	70-24-E301SV
3LSE-12S3X	12	300	175	10066	2868	70-0501	70-0501SV	70-24-0501	70-24-0501SV
3LSE-14S3X	14	350	150	11598	3328	70-0651	70-0651SV	-	-
3LSE-16S3X	16	400	150	15395	4440	70-1300	70-1300SV	-	-
3LSE-18S3X	18	450	150	20120	5509	70-1800	70-1800SV	-	-
3LSE-20S3X	20	500	150	25329	7056	AU-4068	AU-4068SV	-	-

Options/Adders
X = 3-Way Assemblies (Refer to Configuration Chart, Page 6)
For Heater/Thermostat kit, add "H" to the actuator part number.
For Battery Back-Up Failsafe Option (BBU) option on 24 VAC actuators, add "-BBU".

3L Series Butterfly Valves - Close-Off Charts

2-Way with Series 92 Double Acting Pneumatic Actuators

Nylon Coated Disc

2-Way, Double Acting Pneumatic - Nylon Coated Disc												
Actuator Model Details						92-063	92-083	92-119	92-128	92-160	92-210	92-255
Valve Model Details	Size		Close-Off PSI	Cv								
	In.	mm		90°	60°							
3LNE-02S2C	2	50	175	87	66	X	-	-	-	-	-	-
3LNE-25S2C	2.5	65	175	185	98	X	-	-	-	-	-	-
3LNE-03S2C	3	80	175	360	171	X	-	-	-	-	-	-
3LNE-04L2C	4	100	50	740	310	-	X	-	-	-	-	-
3LNE-04S2C	4	100	175	740	310	-	X	-	-	-	-	-
3LNE-05L2C	5	125	50	1218	470	-	X	-	-	-	-	-
3LNE-05S2C	5	125	175	1218	470	-	X	-	-	-	-	-
3LNE-06L2C	6	150	50	1900	757	-	X	-	-	-	-	-
3LNE-06S2C	6	150	175	1900	757	-	X	-	-	-	-	-
3LNE-08L2C	8	200	50	3765	1247	-	-	X	-	-	-	-
3LNE-08S2C	8	200	175	3765	1247	-	-	X	-	-	-	-
3LNE-10L2C	10	250	50	6661	2005	-	-	X	-	-	-	-
3LNE-10S2C	10	250	175	6661	2005	-	-	X	-	-	-	-
3LNE-12L2C	12	300	50	10066	2868	-	-	X	-	-	-	-
3LNE-12S2C	12	300	175	10066	2868	-	-	-	X	-	-	-
3LNE-14L2C	14	350	50	11598	3328	-	-	-	X	-	-	-
3LNE-14S2C	14	350	150	11598	3328	-	-	-	-	X	-	-
3LNE-16L2C	16	400	50	15395	4440	-	-	-	-	X	-	-
3LNE-16S2C	16	400	150	15395	4440	-	-	-	-	-	X	-
3LNE-18L2C	18	450	50	20120	5509	-	-	-	-	-	X	-
3LNE-18S2C	18	450	150	20120	5509	-	-	-	-	-	X	-
3LNE-20L2C	20	500	50	25329	7056	-	-	-	-	-	X	-
3LNE-20S2C	20	500	150	25329	7056	-	-	-	-	-	-	X
3LNE-24L2C	24	600	50	39396	10267	-	-	-	-	-	-	X
NYF2-C301	30	750	75	52443	18090	-	-	-	-	-	-	X

Stainless Steel Disc

2-Way, Spring Return Pneumatic - Nylon Coated Disc												
Actuator Model Details						Series 98 Pneumatic Scotch Yoke (Fail Close)						
Valve Model Details	Size		Close-Off PSI	Cv		98-45E2-12-DA	98-14E3-12-DA-C					
	In.	mm		90°	60°							
3LNE-24S2C	24	600	150	39396	10267	X	-					
NYF2-C300	30	750	150	52443	18090	-	X					

2-Way, Double Acting Pneumatic - Stainless Steel Disc												
Actuator Model Details						92-063	92-083	92-119	92-128	92-160	92-210	92-255
Valve Model Details	Size		Close-Off PSI	Cv								
	In.	mm		90°	60°							
3LSE-02S2C	2	50	175	87	66	X	-	-	-	-	-	-
3LSE-25S2C	2.5	65	175	185	98	X	-	-	-	-	-	-
3LSE-03S2C	3	80	175	360	171	X	-	-	-	-	-	-
3LSE-04L2C	4	100	50	740	310	-	X	-	-	-	-	-
3LSE-04S2C	4	100	175	740	310	-	X	-	-	-	-	-
3LSE-05L2C	5	125	50	1218	470	-	X	-	-	-	-	-
3LSE-05S2C	5	125	175	1218	470	-	X	-	-	-	-	-
3LSE-06L2C	6	150	50	1900	757	-	X	-	-	-	-	-
3LSE-06S2C	6	150	175	1900	757	-	X	-	-	-	-	-
3LSE-08L2C	8	200	50	3765	1247	-	-	X	-	-	-	-
3LSE-08S2C	8	200	175	3765	1247	-	-	X	-	-	-	-
3LSE-10L2C	10	250	50	6661	2005	-	-	X	-	-	-	-
3LSE-10S2C	10	250	175	6661	2005	-	-	X	-	-	-	-
3LSE-12L2C	12	300	50	10066	2868	-	-	X	-	-	-	-
3LSE-12S2C	12	300	175	10066	2868	-	-	-	X	-	-	-
3LSE-14S2C	14	350	150	11598	3328	-	-	-	-	X	-	-
3LSE-16S2C	16	400	150	15395	4440	-	-	-	-	-	X	-
3LSE-18S2C	18	450	150	20120	5509	-	-	-	-	-	X	-
3LSE-20S2C	20	500	150	25329	7056	-	-	-	-	-	-	X

Options/Adders
 * For Manual Override, add "-5" to the end of the part number.
 For Spring Return Units:
 N = Normally Open
 C = Normally Closed - Factory default

3L Series Butterfly Valves - Close-Off Charts

3-Way with Series 92 Double Acting Pneumatic Actuators

Nylon Coated Disc

3-Way, Double Acting Pneumatic - Nylon Coated Disc											
Actuator Model Details						92-063	92-083	92-119	92-160	92-210	92-255
Valve Model Details	Size		Close-Off PSI	Cv							
	In.	mm		90°	60°						
3LNE-02S3X	2	50	175	87	66	X	-	-	-	-	-
3LNE-25S3X	2.5	65	175	185	98	X	-	-	-	-	-
3LNE-03S3X	3	80	175	360	171	X	-	-	-	-	-
3LNE-04L3X	4	100	50	740	310	X	-	-	-	-	-
3LNE-04S3X	4	100	175	740	310	X	-	-	-	-	-
3LNE-05L3X	5	125	50	1218	470	X	-	-	-	-	-
3LNE-05S3X	5	125	175	1218	470	-	X	-	-	-	-
3LNE-06L3X	6	150	50	1900	757	-	X	-	-	-	-
3LNE-06S3X	6	150	175	1900	757	-	X	-	-	-	-
3LNE-08L3X	8	200	50	3765	1247	-	-	X	-	-	-
3LNE-08S3X	8	200	175	3765	1247	-	-	X	-	-	-
3LNE-10L3X	10	250	50	6661	2005	-	-	X	-	-	-
3LNE-10S3X	10	250	175	6661	2005	-	-	X	-	-	-
3LNE-12L3X	12	300	50	10066	2868	-	-	X	-	-	-
3LNE-12S3X	12	300	175	10066	2868	-	-	-	X	-	-
3LNE-14L3X	14	350	50	11598	3328	-	-	-	X	-	-
3LNE-14S3X	14	350	150	11598	3328	-	-	-	-	X	-
3LNE-16L3X	16	400	50	15395	4440	-	-	-	-	X	-
3LNE-16S3X	16	400	150	15395	4440	-	-	-	-	-	X
3LNE-18L3X	18	450	50	20120	5509	-	-	-	-	X	-
3LNE-18S3X	18	450	150	20120	5509	-	-	-	-	-	X
3LNE-20L3X	20	500	50	25329	7056	-	-	-	-	X	-
3LNE-20S3X	20	500	150	25329	7056	-	-	-	-	-	X

Stainless Steel Disc

3-Way, Double Acting Pneumatic - Stainless Steel Disc												
Actuator Model Details						92-063	92-083	92-119	92-128	92-160	92-210	92-255
Valve Model Details	Size		Close-Off PSI	Cv								
	In.	mm		90°	60°							
3LSE-02S3X	2	50	175	87	66	X	-	-	-	-	-	-
3LSE-25S3X	2.5	65	175	185	98	X	-	-	-	-	-	-
3LSE-03S3X	3	80	175	360	171	X	-	-	-	-	-	-
3LSE-04L3X	4	100	50	740	310	X	-	-	-	-	-	-
3LSE-04S3X	4	100	175	740	310	-	X	-	-	-	-	-
3LSE-05L3X	5	125	50	1218	470	-	X	-	-	-	-	-
3LSE-05S3X	5	125	175	1218	470	-	X	-	-	-	-	-
3LSE-06L3X	6	150	50	1900	757	-	X	-	-	-	-	-
3LSE-06S3X	6	150	175	1900	757	-	X	-	-	-	-	-
3LSE-08L3X	8	200	50	3765	1247	-	-	X	-	-	-	-
3LSE-08S3X	8	200	175	3765	1247	-	-	X	-	-	-	-
3LSE-10L3X	10	250	50	6661	2005	-	-	X	-	-	-	-
3LSE-10S3X	10	250	175	6661	2005	-	-	-	X	-	-	-
3LSE-12L3X	12	300	50	10066	2868	-	-	X	-	-	-	-
3LSE-12S3X	12	300	175	10066	2868	-	-	-	-	X	-	-
3LSE-14S3X	14	350	150	11598	3328	-	-	-	-	-	X	-
3LSE-16S3X	16	400	150	15395	4440	-	-	-	-	-	-	X
3LSE-18S3X	18	450	150	20120	5509	-	-	-	-	-	-	X
3LSE-20S3X	20	500	150	25329	7056	-	-	-	-	-	-	X

Options/Adders
 X = 3-Way Assemblies (Refer to Configuration Chart, Page 6)
 * For Manual Override, add "-5" to the end of the part number.

3L Series Butterfly Valves - Close-Off Charts

2-Way with Series 93 & 98 Spring Return Pneumatic Actuators

Nylon Coated Disc

2-Way, Spring Return Pneumatic - Nylon Coated Disc							
Valve Model Details	Actuator Model Details			Cv		Normally Closed (Fail Closed)	Normally Open (Fail Open)
	Size		Close-Off PSI	90°	60°		
	In.	mm					
3LNE-02S2C	2	50	175	87	66	93-0833	93-0832
3LNE-25S2C	2.5	65	175	185	98	93-0833	93-0832
3LNE-03S2C	3	80	175	360	171	93-0834	93-0833
3LNE-04L2C	4	100	50	740	310	93-0833	93-0833
3LNE-04S2C	4	100	175	740	310	93-0836	93-0834
3LNE-05L2C	5	125	50	1218	470	93-0835	93-0834
3LNE-05S2C	5	125	175	1218	470	93-0935	93-0934
3LNE-06L2C	6	150	50	1900	757	93-0935	93-0934
3LNE-06S2C	6	150	175	1900	757	93-1194	93-1193
3LNE-08L2C	8	200	50	3765	1247	93-1194	93-1193
3LNE-08S2C	8	200	175	3765	1247	93-1603	93-1284
3LNE-10L2C	10	250	50	6661	2005	93-1603	93-1283
3LNE-10S2C	10	250	175	6661	2005	93-1605	93-1603
3LNE-12L2C	12	300	50	10066	2868	93-1604	93-1603
3LNE-12S2C	12	300	175	10066	2868	93-2103	93-2102
3LNE-14L2C	14	350	50	11598	3328	93-2103	93-2102
3LNE-14S2C	14	350	150	11598	3328	93-2106	93-2104
3LNE-16L2C	16	400	50	15395	4440	93-2105	93-2103
3LNE-16S2C	16	400	150	15395	4440	93-2554	93-2553
3LNE-18L2C	18	450	50	20120	5509	93-2105	93-2103
3LNE-18S2C	18	450	150	20120	5509	93-2555	93-2553
3LNE-20L2C	20	500	50	25329	7056	93-2553	93-2552
3LNE-20S2C	20	500	150	25329	7056	93-2556	93-2554

Stainless Steel Disc

2-Way, Spring Return Pneumatic - Nylon Coated Disc									
Valve Model Details	Actuator Model Details			Cv		Series 98 Pneumatic Scotch Yoke (Fail Close)			
	Size		Close-Off PSI	90°	60°	98-45E2-12-SR3	98-73E2-14-SR4-C	98-73E2-14-SR3-C	98-14E3-14-SR3-C
	In.	mm							
3LNE-24L2C	24	600	50	39396	10267	X	-	-	-
3LNE-24S2C	24	600	150	39396	10267	-	X	-	-
NYF2-C301	30	750	75	52443	18090	-	-	X	-
NYF2-C300	30	750	150	52443	18090	-	-	-	41094

2-Way, Spring Return Pneumatic - Stainless Steel Disc							
Valve Model Details	Actuator Model Details			Cv		Normally Closed (Fail Closed)	Normally Open (Fail Open)
	Size		Close-Off PSI	90°	60°		
	In.	mm					
3LSE-02S2C	2	50	175	87	66	93-0833	93-0832
3LSE-25S2C	2.5	65	175	185	98	93-0833	93-0833
3LSE-03S2C	3	80	175	360	171	93-0834	93-0833
3LSE-04L2C	4	100	50	740	310	93-0834	93-0833
3LSE-04S2C	4	100	175	740	310	93-0935	93-0933
3LSE-05L2C	5	125	50	1218	470	93-0835	93-0834
3LSE-05S2C	5	125	175	1218	470	93-1193	93-1194
3LSE-06L2C	6	150	50	1900	757	93-0935	93-0934
3LSE-06S2C	6	150	175	1900	757	93-1194	93-1193
3LSE-08L2C	8	200	50	3765	1247	93-1195	93-1193
3LSE-08S2C	8	200	175	3765	1247	93-1603	93-1283
3LSE-10L2C	10	250	50	6661	2005	93-1603	93-1283
3LSE-10S2C	10	250	175	6661	2005	93-1605	93-1603
3LSE-12L2C	12	300	50	10066	2868	93-1605	93-1603
3LSE-12S2C	12	300	175	10066	2868	93-2104	93-2103
3LSE-14S2C	14	350	150	11598	3328	93-2553	93-2552
3LSE-16S2C	16	400	150	15395	4440	93-255	93-2554
3LSE-18S2C	18	450	150	20120	5509	93-2553	93-2553

2-Way, Spring Return Pneumatic - Stainless Steel Disc							
Valve Model Details	Actuator Model Details			Cv		Series 98 Pneumatic Scotch Yoke (Fail Close)	
	Size		Close-Off PSI	90°	60°	98-45E2-12-SR3	98-14E3-14-SR3-C
	In.	mm					
3LSE-20S2C	20	500	150	25329	7056	X	-
3LSE-24S2C	24	600	150	39396	10267	X	-
NYF2-C301	30	750	75	52443	18090	X	-
NYF2-C300	30	750	150	52443	18090	-	X

Options/Adders
 * For Manual Override, add "-5" to the end of the part number.
 For Spring Return Units:
 N = Normally Open
 C = Normally Closed - Factory default

3L Series Butterfly Valves - Close-Off Charts

3-Way with Series 93 Spring Return Pneumatic Actuators

Nylon Coated Disc

3-Way, Spring Return Pneumatic - Nylon Coated Disc											
Actuator Model Details						93-0834	93-0935	93-1194	93-1605	93-2105	93-2554
Valve Model Details	Size		Close-Off PSI	Cv							
	In.	mm		90°	60°						
3LNE-02S3X	2	50	175	87	66	X	-	-	-	-	-
3LNE-25S3X	2.5	65	175	185	98	X	-	-	-	-	-
3LNE-03S3X	3	80	175	360	171	X	-	-	-	-	-
3LNE-04L3X	4	100	50	740	310	X	-	-	-	-	-
3LNE-04S3X	4	100	175	740	310	-	X	-	-	-	-
3LNE-05L3X	5	125	50	1218	470	-	X	-	-	-	-
3LNE-05S3X	5	125	175	1218	470	-	-	X	-	-	-
3LNE-06L3X	6	150	50	1900	757	-	X	-	-	-	-
3LNE-06S3X	6	150	175	1900	757	-	-	X	-	-	-
3LNE-08L3X	8	200	50	3765	1247	-	-	X	-	-	-
3LNE-08S3X	8	200	175	3765	1247	-	-	-	X	-	-
3LNE-10L3X	10	250	50	6661	2005	-	-	-	X	-	-
3LNE-10S3X	10	250	175	6661	2005	-	-	-	X	-	-
3LNE-12L3X	12	300	50	10066	2868	-	-	-	X	-	-
3LNE-12S3X	12	300	175	10066	2868	-	-	-	-	X	-
3LNE-14L3X	14	350	50	11598	3328	-	-	-	-	X	-
3LNE-14S3X	14	350	150	11598	3328	-	-	-	-	-	X
3LNE-16L3X	16	400	50	15395	4440	-	-	-	-	-	X
3LNE-18L3X	18	450	50	20120	5509	-	-	-	-	-	X
3LNE-20L3X	20	500	50	25329	7056	-	-	-	-	-	X

Stainless Steel Disc

3-Way, Spring Return Pneumatic - Stainless Steel Disc											
Actuator Model Details						93-0835	93-0935	93-1195	93-1605	93-2105	93-2554
Valve Model Details	Size		Close-Off PSI	Cv							
	In.	mm		90°	60°						
3LSE-02S3X	2	50	175	87	66	X	-	-	-	-	-
3LSE-25S3X	2.5	65	175	185	98	X	-	-	-	-	-
3LSE-03S3X	3	80	175	360	171	X	-	-	-	-	-
3LSE-04L3X	4	100	50	740	310	X	-	-	-	-	-
3LSE-04S3X	4	100	175	740	310	-	X	-	-	-	-
3LSE-05L3X	5	125	50	1218	470	X	-	-	-	-	-
3LSE-05S3X	5	125	175	1218	470	-	-	X	-	-	-
3LSE-06L3X	6	150	50	1900	757	-	X	-	-	-	-
3LSE-06S3X	6	150	175	1900	757	-	-	X	-	-	-
3LSE-08L3X	8	200	50	3765	1247	-	-	X	-	-	-
3LSE-08S3X	8	200	175	3765	1247	-	-	-	X	-	-
3LSE-10L3X	10	250	50	6661	2005	-	-	-	X	-	-
3LSE-10S3X	10	250	175	6661	2005	-	-	-	X	-	-
3LSE-12L3X	12	300	50	10066	2868	-	-	-	X	-	-
3LSE-12S3X	12	300	175	10066	2868	-	-	-	-	X	-
3LSE-14S3X	14	350	150	11598	3328	-	-	-	-	-	X
3LSE-16S3X	16	400	150	15395	4440	-	-	-	-	-	X
3LSE-18S3X	18	450	150	20120	5509	-	-	-	-	-	X
3LSE-20S3X	20	500	150	25329	7056	-	-	-	-	-	X

Options/Adders
X = 3-Way Assemblies (Refer to Configuration Chart, Page 6)
* For Manual Override, add "-5" to the end of the part number.

3L Series Butterfly Valves - Close-Off Charts

2 & 3-Way with Low Pressure Pneumatic Actuators

Nylon Coated Disc

2-Way, Low Pressure Pneumatic - Nylon Coated Disc					D-3153	D-3244	D-3246	D-3246-D
Actuator Model Details					Single Actuator	Tandem Actuators		
Valve Model Details	Size		Close-Off PSI	Cv 70°				
	In.	mm						
3LNE-02S2C	2	50	175	73	X	-	-	-
3LNE-25S2C	2-1/2	65	175	141	X	-	-	-
3LNE-03S2C	3	80	175	256	X	-	-	-
3LNE-04L2C	4	100	50	505	X	-	-	-
3LNE-04S2C	4	100	175	505	-	X	-	-
3LNE-05L2C	5	125	50	759	-	X	-	-
3LNE-05S2C	5	125	175	759	-	-	X	-
3LNE-06L2C	6	150	50	1190	-	-	X	-
3LNE-06S2C	6	150	175	1190	-	-	X	-
3LNE-08L2C	8	200	50	2096	-	-	X	-
3LNE-08S2C	8	200	175	2096	-	-	-	X
3LNE-10L2C	10	250	50	3342	-	-	-	X

3-Way, Low Pressure Pneumatic - Nylon Coated Disc					D-3153	D-3244	D-3246	D-3246-D
Actuator Model Details					Single Actuator	Tandem Actuators		
Valve Model Details	Size		Close-Off PSI	Cv 70°				
	In.	mm						
3LNE-02S3x	2	50	175	73	X	-	-	-
3LNE-25S3x	2-1/2	65	175	141	-	X	-	-
3LNE-03S3x	3	80	175	256	-	X	-	-
3LNE-04L3x	4	100	50	505	-	X	-	-
3LNE-04S3x	4	100	175	505	-	-	X	-
3LNE-05L3x	5	125	50	759	-	-	X	-
3LNE-05S3x	5	125	175	759	-	-	X	-
3LNE-06L3x	6	150	50	1190	-	-	X	-
3LNE-06S3x	6	150	175	1190	-	-	-	X
3LNE-08L3x	8	200	50	2096	-	-	-	X

Stainless Steel Disc

2-Way, Low Pressure Pneumatic - Stainless Steel Disc					D-3153	D-3244	D-3246	D-3246-D
Actuator Model Details					Single Actuator	Tandem Actuators		
Valve Model Details	Size		Close-Off PSI	Cv 70°				
	In.	mm						
3LSE-02S2C	2	50	175	73	X	-	-	-
3LSE-25S2C	2.5	65	175	141	X	-	-	-
3LSE-03S2C	3	80	175	256	X	-	-	-
3LSE-04L2C	4	100	50	505	X	-	-	-
3LSE-04S2C	4	100	175	505	-	X	-	-
3LSE-05L2C	5	125	50	759	-	X	-	-
3LSE-05S2C	5	125	175	759	-	-	X	-
3LSE-06L2C	6	150	50	1190	-	-	X	-
3LSE-06S2C	6	150	175	1190	-	-	X	-
3LSE-08L2C	8	200	50	2096	-	-	X	-
3LSE-08S2C	8	200	175	2096	-	-	-	X
3LSE-10L2C	10	250	50	3342	-	-	-	X

3-Way, Low Pressure Pneumatic - Stainless Steel Disc					D-3153	D-3244	D-3246	D-3246-D
Actuator Model Details					Single Actuator	Tandem Actuators		
Valve Model Details	Size		Close-Off PSI	Cv 70°				
	In.	mm						
3LSE-02S3x	2	50	175	73	X	-	-	-
3LSE-25S3x	2.5	65	175	141	-	X	-	-
3LSE-03S3x	3	80	175	256	-	X	-	-
3LSE-04L3x	4	100	50	505	-	X	-	-
3LSE-04S3x	4	100	175	505	-	-	X	-
3LSE-05L3x	5	125	50	759	-	-	X	-
3LSE-05S3x	5	125	175	759	-	-	X	-
3LSE-06L3x	6	150	50	1190	-	-	X	-
3LSE-06S3x	6	150	175	1190	-	-	-	X
3LSE-08L3x	8	200	50	2096	-	-	-	X

Options/Adders
 X = 3-Way Assemblies (Refer to Configuration Chart, Page 6)
 -D = Dual mounted actuators