

Selection Guide | VLT® HVAC Drive FC 102

Drive down operating costs, with the leader in HVAC efficiency

98%

Energy efficiency

Save energy and
money with HVAC-
optimized drives



Content

The best in HVAC is now better than ever.....	4	Flexible, modular and adaptable	16
Nothing beats know how and experience.....	5	Modular simplicity – A, B and C enclosures.....	18
Savings throughout your entire lifecycle.....	6	High-power modularity – D, E and F enclosures.....	20
Guaranteed operation in your application.....	7	Engineered for cost savings via intelligent heat	
An unsurpassed fit.....	8	management, compactness and protection.....	22
Dedicated fan functionality.....	9	Optimize performance and grid protection.....	24
Air Handling Units.....	9	Connection example.....	26
Dedicated pump functionality.....	10	Technical data.....	27
Your purpose. Your drive. Your way.....	11	Electrical data – A, B, and C enclosures.....	28
Free to connect.....	12	Dimensions enclosure sizes A, B and C.....	30
Free to equip.....	13	Ordering typecode for A, B and C enclosures.....	31
Personalize your drive.....	14	Electrical data – D, E and F enclosures.....	32
Integrate safely.....	15	Dimensions enclosure sizes D, E and F.....	33



Dedicated drive for highest **energy efficiency** and **reliability**

The VLT® HVAC Drive FC 102 is a dedicated, globally supported drive that combines flexibility and efficiency in a package designed to minimize total system and lifecycle costs in HVAC applications.

The VLT® HVAC Drive is the preferred AC drive for heating, ventilation and air conditioning systems throughout the world. Designed to be installed in any fan or pump system and efficiently operate induction, permanent magnet, and high-efficiency synchronous reluctance motors, you can count on the VLT® HVAC Drive to provide years of reliable, maintenance-free operation.

The Danfoss EC+ concept pairs the VLT® HVAC Drive with high-efficiency motor technologies, with efficiency classes of IE3 and above. EC+ provides building owners with a flexible and future-proof system that is able to meet and exceed increasingly stringent environmental and efficiency-focused legislation in a cost effective way.

Every VLT® HVAC Drive is based on 30 years of experience and innovation. Easy to use, all models follow the same basic design and operating principle. Once you know one, you know them all. This selection guide helps you to choose and configure your perfect drive for applications in the range 1.1-1400 kW.

Electrical data and dimensions – VLT® 12-Pulse	34
Ordering typecode for D, E and F enclosures	36
Electrical data – VLT® Low Harmonic Drive and VLT® Advanced Active Filters	38
A options: Fieldbuses	41
B options: Functional extensions	42
C options: Motion control and relay card	43
D option: 24 V back-up power supply	43
Accessories	45
Power options	47
Accessory compatibility with enclosure size	48
Loose kits for enclosure sizes D, E and F	50



IM
Three-phase
induction motor
with copper rotor



SPM
PM motor with
surface-mounted
magnets



IPM
Line-start PM motor
with buried magnets
and rotor cage

SynRM
Synchronous
reluctance motor

The **best** in HVAC is now **better than ever**

As the world's population continues to increase, energy-optimized HVAC systems are the key to providing comfort and safety without increasing energy consumption. Even extreme climates and isolated outposts have a need for efficient HVAC operation. To give you the flexibility you need with the reliability you expect, the VLT® HVAC Drive has been enhanced to meet your needs – and more.

Enhanced efficiency

New motor technologies are driving an increase in operating efficiency, especially in HVAC applications. To get the most out of these permanent magnet (PM) and synchronous reluctance (SynRM) motors, you need an AC drive equipped with the algorithms to most optimally control these motors.

Go outdoors with
extreme-climate
performance from
+50 °C down to

-25°C

Enhanced connectivity

HVAC applications can be found everywhere, with installations in isolated areas of the world or in difficult-to-access locations. This requires new ways of thinking in order to efficiently communicate to these drives.

With the availability of the most common HVAC communications protocols today, the VLT® HVAC Drive can be integrated seamlessly to practically any building automation control network. Web servers integrated in the Ethernet™ options provide for even more ways to securely and remotely connect to your drive.

Small investment – big returns

New energy efficiency regulations focus on ways to reduce energy consumption and CO₂ emissions. To meet these new standards, adding an AC drive is a necessity. Over the lifetime of an AC drive, energy cost is the dominating economical factor, but savings can be found in other associated costs.

Selecting the VLT® HVAC Drive provides the lowest total cost of ownership. Installation and commissioning take less time, and operating efficiency is higher than for other comparable drives. And, based on average operating time, the VLT® HVAC Drive will operate maintenance-free for up to 10 years.

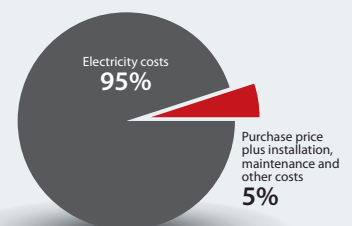



Nothing beats know how and experience

VLT® HVAC Drive is built to **deliver** the **ultimate cost efficiency**

Total cost of ownership

A variety of costs come into play when looking at the total lifecycle of your AC drive. From time spent gathering specifications and engineering the solution, to the purchase price, to installation, commissioning, operation and maintenance costs, the VLT® HVAC Drive has the perfect mix of quality and features to ensure these costs are minimized over the life of the AC drive.

Reliability

AC drives in HVAC applications see some of the most extreme aspects of the environment. From the frozen tundras to the scorching deserts, VLT® HVAC Drives are exposed to a wide range of operating temperatures. Additionally, AC drives are often used in areas of the world where seismic activity is common or where they are exposed to potentially corrosive atmospheres. You can count on the VLT® HVAC Drive to continuously operate in all of these conditions.

HVAC expertise

Applications in HVAC are extremely well positioned for energy savings, resulting in reduced energy costs and lowering a building's carbon footprint. New, more efficient motors being used in these applications require unique motor control algorithms in order to optimize their operation. Enabling the user to program their VLT® HVAC Drive in terms commonly used in the HVAC industry ensures that the AC drive is quickly commissioned and always operating with optimal efficiency.

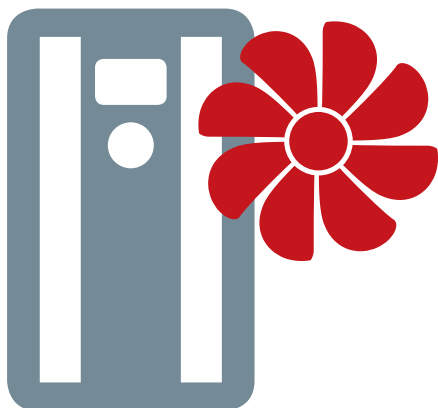

**Total
cost of
ownership**

Reliability

**HVAC
expertise**

- Your purpose, your drive, your way**
- Know-how and experience**
- Proven quality**
- DrivePro® Services**



Savings throughout your entire lifecycle

When you partner with Danfoss, your savings start from the moment you consider installing a VLT® HVAC Drive in your application. What's your need? Easy access to electrical and mechanical drawings and other key documentation? An AC drive that's quick and easy to install? An AC drive that efficiently operates your motor? Or a partner that's available to you 24/7? We offer it all and you can count on savings every step of the way.

Total cost of ownership

5

reasons to choose the VLT® HVAC Drive

1. Energy efficiency
2. Optimal motor control
3. User friendliness
4. Fieldbus availability
5. Personalize your drive

Energy efficiency

Energy efficiency of the AC drive includes more than the drive itself. Through a combination of minimizing thermal losses, low standby power consumption and a demand-based cooling fan, the VLT® HVAC Drive operates at over 98% efficiency.

Optimal motor control

Efficiency is very much based on which motor is best suited for your application. Whether you use an induction motor (IM), a permanent magnet motor (PM) or a synchronous reluctance motor (SynRM), you can be certain that your VLT® HVAC Drive will provide reliable, accurate motor control. Using Automatic Motor Adaptation (AMA) and Automatic Energy Optimization (AEO) functions further ensures that your motor is always operating as efficiently as possible.

User friendliness

Installation, commissioning and maintenance can be some of the most time and cost-intensive steps in the life cycle of an AC drive. To minimize the impacts of these steps, the VLT® HVAC Drive features a common control panel that includes SmartStart application guides, HVAC-specific parameter names, spring loaded I/O terminals, easy-to-access power and motor terminals, and a built-in USB port for interfacing with the VLT® Motion Control Tool MCT 10 PC tool.

Fieldbus availability

The ability to easily integrate your AC drive into your building automation system is a key to optimal control. The VLT® HVAC Drive features a number of HVAC-specific communication protocols, such as BACnet/IP, that allow for a great level of flexibility of installation in both new and existing building automation systems.

Personalize your drive

Occasionally, we work with partners where our standard HVAC application works well, but some modifications make the VLT® HVAC Drive even better suited to their applications.

In these cases, we can offer the VLT® Software Customizer that allows for custom parameter names, alarms and warnings, configurable application specific SmartStart guides, and even a custom splash screen for the control panel.

Additionally, where there's a high level of commonality in the application and parameter settings, a unique set of customer specific initial values (CSIV) can be defined. This CSIV can then be loaded in the drive, replacing the factory default values with the customer specified default values.

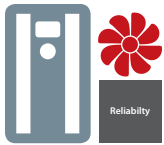

Guaranteed operation in your application

These days, your HVAC applications are often challenged by temperature fluctuations, seismic activity, areas with high levels of atmospheric pollutants, unstable grid quality or a mixture of these conditions. Knowing this, the VLT® HVAC Drive has been equipped to give you the tools to meet these challenges and more. Day in and day out, wherever you face them, you'll have an AC drive that you can always rely on.

Reliability

5

reasons to choose the VLT® HVAC Drive

1. Quality
2. Environment
3. Uptime
4. Electrical immunity
5. Global 24/7 support

Quality

Our goal has always been to provide you with products and systems of the best possible quality, functionality and efficiency. To improve our service to you even further, we have implemented the ISO/TS 16949 standard. This standard builds on the previous ISO 9001 guidelines but is far more ambitious in scope, addressing not just what we should do but how we should do it. The TS 16949 standard is about understanding your needs and meeting them with products, solutions and services that match your expectations

Environment

With a wide operating temperature down to -25 °C and up to 50 °C and an availability of enclosure classes up to IP66/UL Type 4X, the VLT® HVAC Drive can operate almost anywhere without derating. The addition of seismic certification, the ability to install to altitudes of 2000m/6500ft without

derating and options for conformal, harsh environment coating to 3C3, further improves the VLT® HVAC Drive's ability to work in the most demanding environments.

Uptime

With billions of people all around the world relying on HVAC systems for comfort and safety, one of the key focuses is selecting an AC drive that can withstand unforeseen grid fluctuations that would otherwise interrupt operations. To improve ride-through, the VLT® HVAC Drive relies on a robust overvoltage controller, kinetic backup and an improved flying start which ensures reliable operation when it's needed most.

Electrical immunity

AC drives often require connections to grids that are far from perfect. Here a host of electrical events can cause serious issues with drives. Algorithms in the VLT® HVAC Drive ensure that

even when there are spikes and dips in voltage, that the drive will continue to operate as expected. Occasionally, an AC drive may be connected to a system that experiences a short circuit which could potentially destroy the connected drive. To ensure reliable operation, the VLT® HVAC Drive is designed to be short-circuit-proof with a 100 kA prospective short circuit current capability.

Global 24/7 support

Should you need any kind of support, any time, at any location, we will be there for you. We understand that your uptime is critical, and we react fast.

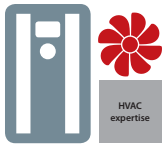

An unsurpassed fit

When searching for the best AC drive for your application, you want to find a partner that understands your needs and challenges. With over 30 years dedicated to HVAC applications, we've heard your comments and continually added the most requested features. As a result of your close cooperation, the VLT® HVAC Drive is a drive that speaks your language, is reliable enough to be installed where you need it, and saves you time and money throughout its lifetime.

HVAC expertise

5

reasons to choose the VLT® HVAC Drive

1. Safety
2. EMC and harmonics
3. Documented savings
4. Efficiency classification
5. Dedicated HVAC functionality

Safety

HVAC applications require a wide and varying consideration for safety in order to protect both the people around the equipment and the equipment itself. To aid this, the VLT® HVAC Drive features a series of options for basic and advanced functional safety, ATEX certified inputs and a lockable mains disconnect as part of the enclosure. This ensures that your AC drive is suitable for the level of safety that your application requires.

EMC and harmonics

The VLT® HVAC Drive is often installed in applications alongside other highly sensitive electronic equipment. Therefore special care is required to minimize electromagnetic interference. To accomplish this, we've added EMC filters guaranteed to levels of Residential Category C1 (up to 50 m length) for screened motor cable; and to levels of Residential Category C2 (up to 150 m length) for screened

motor cable. These filters are also designed to minimize radio-frequency interference (RFI) to even further protect sensitive equipment from radiated emissions.

When AC drives are used, the pulse width modulated output waveform injects harmonics onto the grid. To help mitigate this, VLT® Advanced Harmonic Filters 005 can be used to guarantee a THDi below 5% from the drive.

Documented savings

Almost all owners and operators of AC drives aim to reduce the amount of energy used in their applications. Understanding how adding an AC drive benefits your particular application and saves energy is extremely useful when engineering a solution. Additionally, the ability to see how much energy is being used by your drive is extremely valuable to ensuring that your application runs as efficiently as planned.

To support this, our VLT® Energy Box tool can be used to calculate the potential energy savings, based on logged real-life operation data. The VLT® HVAC Drive features a built-in energy meter which can be used to see how much energy has been consumed by each drive in your application.

Efficiency classification

Using the Danfoss ecoSmart tool, you can enter information about your selected motor, load points and the specific VLT® HVAC Drive in order to calculate and document the efficiency of both the drive being used and the system efficiency class according to EN 50598-2.

Dedicated HVAC functionality

Dedicated fan and pump applications ensure that the VLT® HVAC Drive always meets your needs.

Dedicated fan functionality

Pressure to flow conversion

This means you can set the drive up to provide a fixed flow or fixed differential flow, eliminating the need for an external flow sensor. As a result, energy consumption is optimized, complexity in the system is reduced, all while improving comfort.

Fire override mode

This safety feature prevents the drive from stopping to protect itself. Instead it will continue vital fan operation regardless of control signals, warnings or alarms. Fire override mode is critical for ensuring that people are able to more safely evacuate a building in case of a fire.

Extended BMS capacity

Easy integration into building management systems (BMS) provides managers with detailed information about the current state of the infrastructure in the building. All of the I/O points in the drive are available as remote I/O to extend the capacity of the BMS.

Air Handling Units

Efficiency standards

New legislation being passed around the world, including more stringent efficiency standards on Roof Top Units in the US and Ventilation Units in Europe, will require variable speed controls on most air handling units. Additionally, some of the standards require visual warnings for changing of installed filters to ensure operating efficiency. The VLT® HVAC Drive is uniquely suited to meet these needs and more.

Air Filter Monitoring

Meeting the new requirements for visual filter monitoring can be a costly addition, especially when requiring an external enclosure to house the pressure sensor. To make the addition of these pressure sensors easier and more cost effective, we've developed the VLT® Pressure Transmitter PTU 025 option. This option, featuring three pressure ranges up to 2500 Pa, can easily be attached directly to the VLT® HVAC Drive without the need for an additional external enclosure.

Remote LCP Mounting

When the VLT® HVAC Drive is utilized in air handling units (AHUs), the drive is often mounted inside the AHU housing. These housings typically have thick, insulated walls. The wall thickness makes remote mounting of the LCP challenging, as most remote mounting kits are designed for the thin walls of standard enclosures.

The LCP Remote Mounting Kit deals with this issue, since it is easy to install on panels and walls 1- 90 mm thick. It is compact and cost-effective.

Additionally, the cover on the kit will hold itself up, blocking the sun while you program the LCP, or you can close and lock it while keeping the On/ Alarm/Warning LEDs visible. Read more under 'Accessories'.



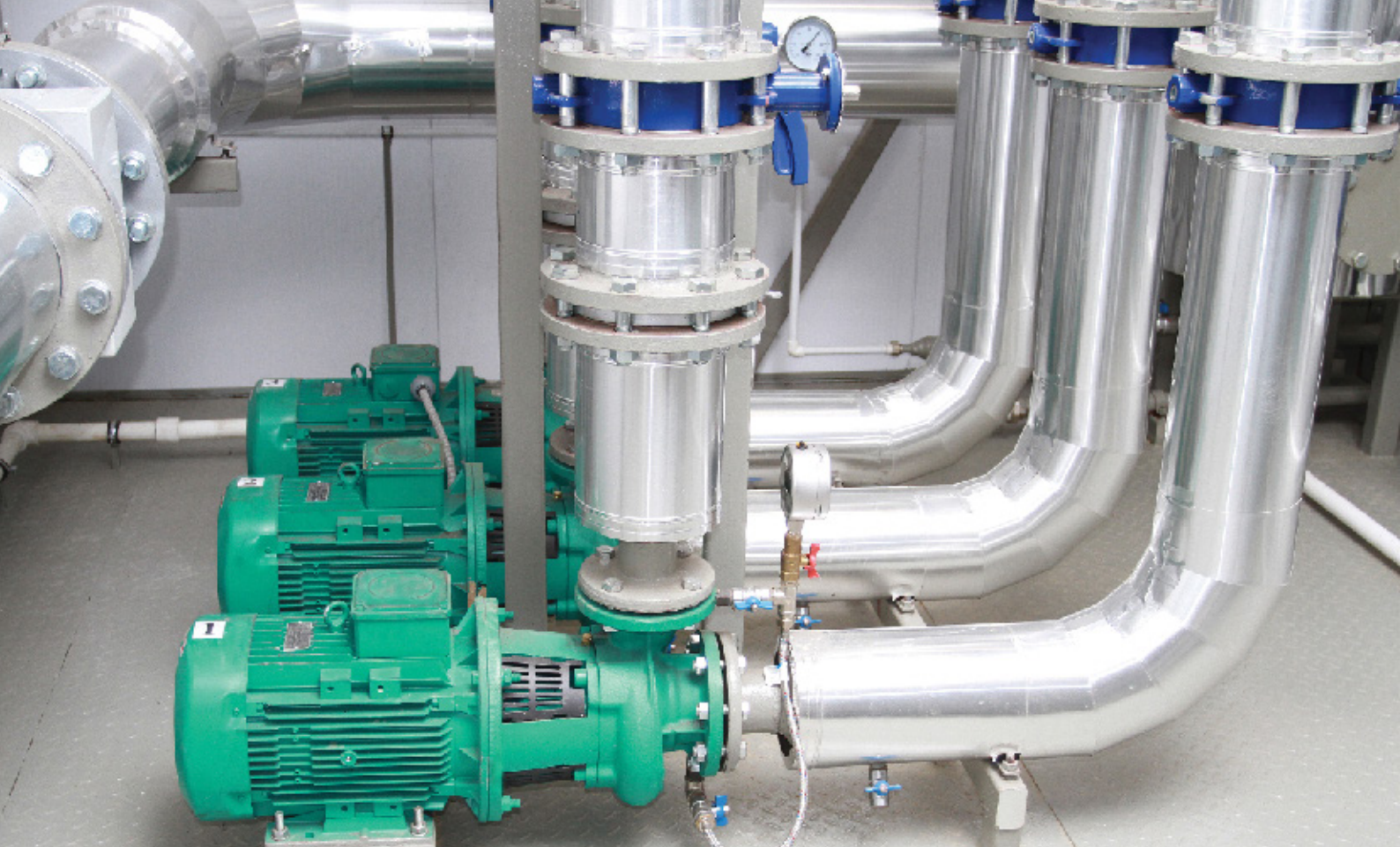

Dedicated pump functionality

Embedded pump controller

The Pump Cascade Controller distributes operation hours evenly across all pumps. Wear and tear on individual pumps is therefore reduced to a minimum, extending their lifetime expectancy and reliability considerably.

Vital water supply

If a pipe leaks or breaks, the VLT® HVAC Drive can reduce the motor speed to prevent overload, while continuing to supply water at a lower speed.

Sleep mode

In situations with low or no flow, the drive enters sleep mode to conserve energy. When the pressure falls below the pre-defined setpoint, the drive starts automatically. Compared to continuous operation this method reduces energy costs and equipment wear and tear, extending the lifetime of the application.

1. Dry pump protection and end of curve

If the pump runs without creating the desired pressure, the drive sets off an alarm or performs another pre-programmed action. This happens for example when a well runs dry or a pipe leaks.

2. Auto tuning of PI controllers

Auto tuning enables the drive to monitor how the system reacts to corrections made by the drive constantly. The drive learns from it and calculates the P and I values, so precise and stable operation is restored quickly.

3. Flow compensation

A pressure sensor mounted close to the fan or pump provides a reference point that enables pressure to be kept constant at

the discharge end of the system. The drive constantly adjusts the pressure reference to follow the system curve. This method both saves energy and reduces installation costs.

4. No/low flow

During operation, a pump normally consumes more power the faster it runs. In situations where the pump runs fast, but is not fully loaded, and does not consume adequate power, the drive compensates accordingly. This is a particular advantage when water circulation stops, the pump runs dry or when pipes leak.



Your **Purpose**, Your **Drive**, **Your Way**

Freedom to optimize

When it comes to optimizing system efficiency to meet your needs exactly, the right components are vital. Whether it's a particular vendor, certain motor technology or a standardized way to communicate, Danfoss Drives can provide the right AC drive to meet your specific needs. You'll always get the most flexible VLT® drive adapted to:

- Meet the unique requirements of your applications
- Operate at peak performance
- Optimize system efficiency

When you have the freedom to select the optimal components for your system, a potential energy saving of up to 60% is possible.

Free to connect

Real time information is becoming increasingly important in industrial automation and control systems as we progress further into Industry 4.0. Immediate access to data increases transparency in production facilities, while making it possible to optimize system performance, collect and analyze system data and provide remote support around the clock from anywhere in the world.

Regardless of your application or your preferred communication protocol, AC drives have an extremely wide variety of communication protocols to select from. In this way you can ensure that the AC drive integrates seamlessly into your chosen system providing you the freedom to communicate however you see fit.

Increase productivity

Fieldbus communication reduces capital costs in production plants. In addition to the initial savings achieved through the significant reduction in wiring and control boxes, fieldbus

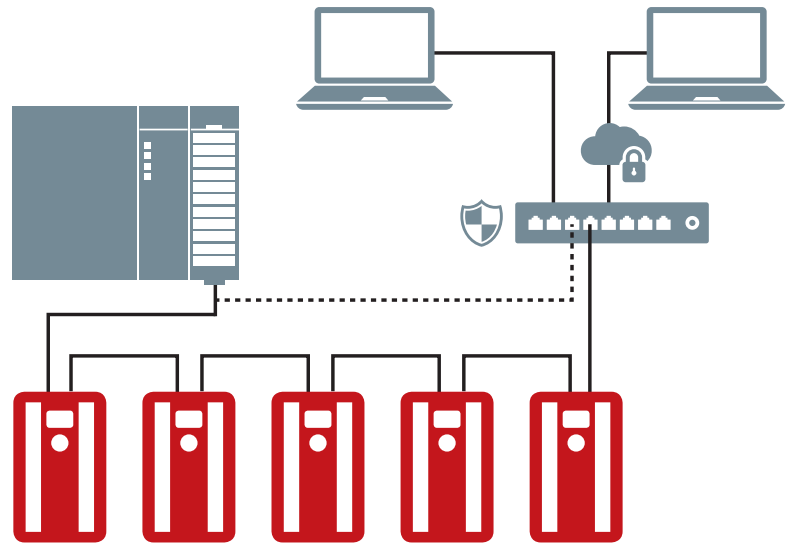

networks are easier to maintain, while providing improved systems performance.

User friendly and fast setup

Danfoss fieldbuses can be configured via the drive's local control panel, which features a user friendly interface with support for many user languages.

The drive and fieldbus can also be configured using the software tools that support each drive family. Danfoss Drives offers fieldbus drivers and PLC examples for free from the Danfoss Drives website to make integration to your system even easier.



DeviceNet

EtherNet/IP



Free to equip

With increasingly stringent demands on motor efficiency, traditional induction motors (IM) cannot always comply. New motor technologies, therefore, continue to emerge, extending both full-load and part-load efficiency.

The unique requirements of these newer motor technologies – such as permanent magnet (PM) motors and synchronous reluctance (SynRM) motors – also demand special motor control algorithms within the AC drive.

All VLT® drives have the built-in capabilities to control whatever motor technology your application requires, at optimum efficiency, meaning the required performance of your system is always available exactly when you need it.

Each VLT® drive is configurable, compatible and efficiency-optimized for all standard motor types. This means you can escape the restrictions of motor-drive package deals.

As an independent manufacturer of AC drive solutions, Danfoss is committed to supporting all commonly used motor types and fostering ongoing development.

To further the degree of efficiency with which induction motors can operate, each VLT® drive features a powerful Automatic Energy Optimization (AEO) function that reduces motor current and voltage whenever possible during operation, resulting in additional energy savings of up to 5%.

Easy commissioning for optimal efficiency

VLT® drives make commissioning equally easy for all motor types by combining ease of use with additional helpful functions such as SmartStart and Automatic Motor Adaptation (AMA), which measures the motor characteristics and optimizes the motor parameters accordingly. This way the motor always operates at the highest possible efficiency, allowing you to reduce energy consumption and cut costs.

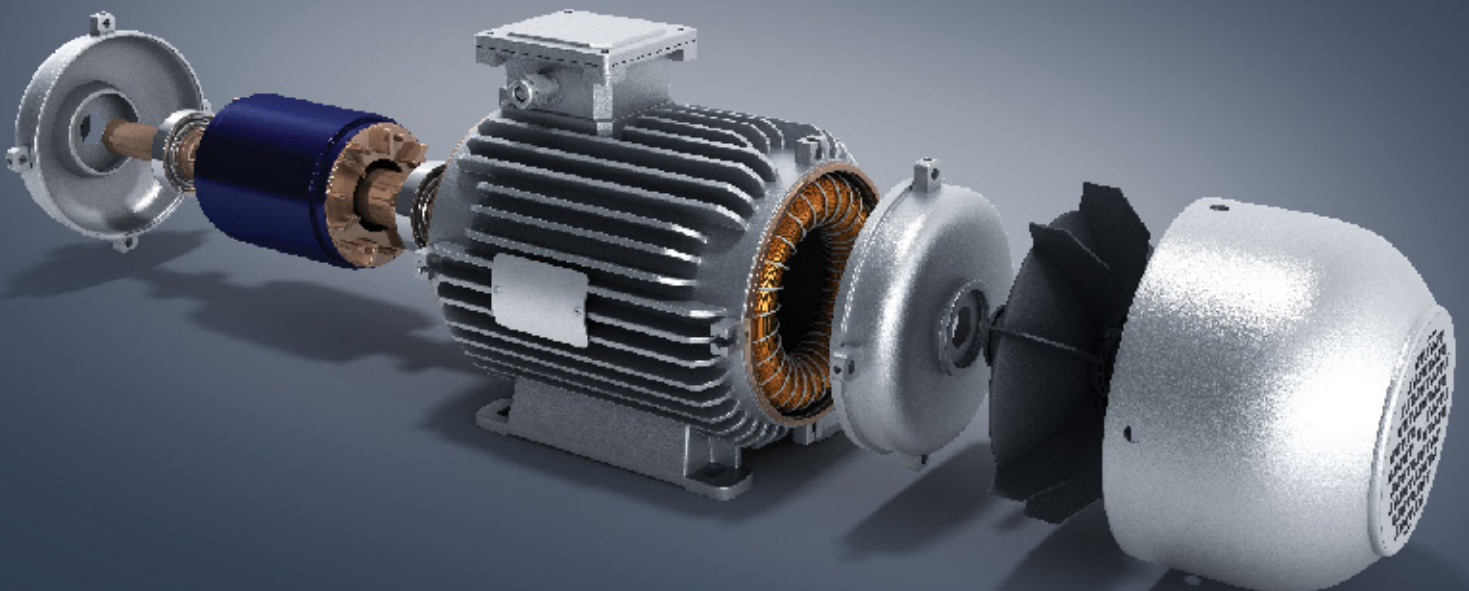



Personalize your drive

When it comes to working with technology such as AC drives, it is fairly easy to feel lost while navigating through hundreds of parameters.

Using a graphical interface makes this process much easier; especially when it lists parameters in your native language. As many as 27 choices are available, including several Cyrillic, Arabic (right to left) and Asian options.

Additionally, the ability to save up to 50 user-selectable parameters further simplifies interactions with key parameter settings for your unique application.

The graphical local control panel (GLCP) featured in VLT® drives is hot-pluggable and can be mounted remotely when your application requires.

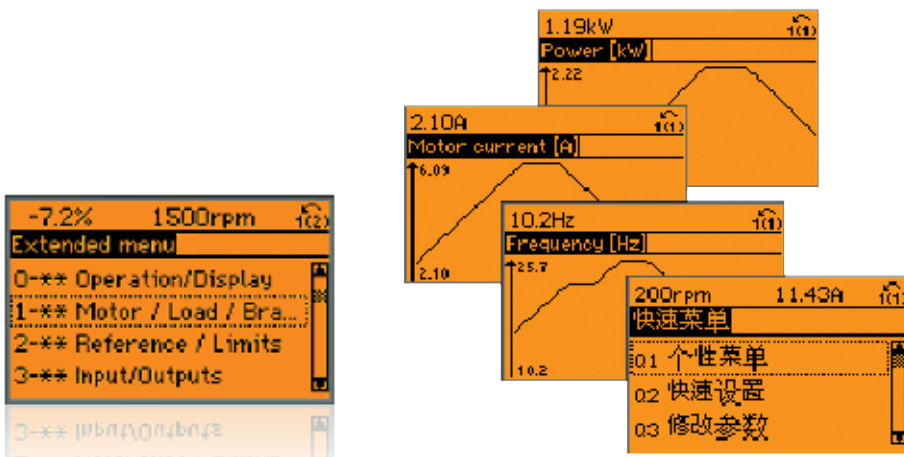

Integrate safely

Fire override mode

Activating the function "Fire-mode" within the VLT® drive ensures secure and continued operation in applications such as stair-well pressurization, car park exhaust fans, smoke exhaust and essential service functions.

Multi-zone Fire-mode

The VLT® HVAC Drive also features a multi-zone fire-mode function that allows for independent speed controls depending on the zone where the alarm originated. Utilizing the logic within the drive allows for a less complex and more reliable smoke extraction system that can react independently to multiple zones as needed.

Drive bypass

If a drive bypass is available the VLT® HVAC Drive will not only sacrifice itself; it will also bypass itself and connect the motor directly to mains. As a result fan functionality will be maintained after the drive fails, as long as there is power and the motor is functioning. *(only available in the USA)*

Functional safety

The VLT® HVAC Drive FC 102 is able to provide the STO (Safe Torque Off) function in compliance with ISO 13849-1 PL d and SIL 2, according to IEC 61508/IEC 62061. In high demand applications this can be expanded with the VLT® Safe Option MCB 140, an external module that provides functions such as Safe Stop 1 (SS1), Safe Limited Speed (SLS), Safe Maximum Speed (SMS), control of external contactors and safety door monitoring and unlocking.

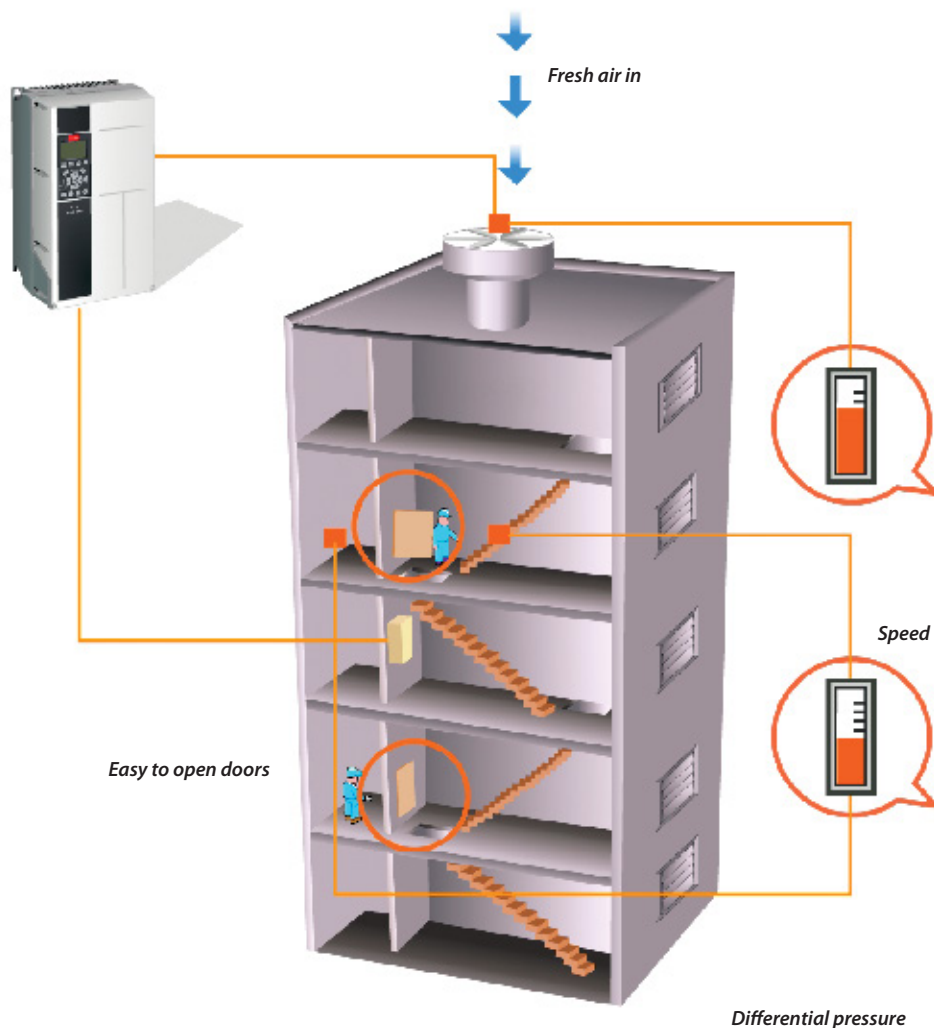

Flexible, modular and adaptable Built to last

The VLT® HVAC Drive is built on a flexible, modular design to provide an extraordinarily versatile motor control solution. Equipped with a wide range of HVAC features, owners can achieve optimal fan and pump control, higher quality output and reduce costs related to spare parts and service, and much more.

Reduce costs with compact drives

A compact design and efficient heat management enable the drive to take up less space in control rooms and panels in various environments. Especially impressive is the 400 V version, which is among the smallest in its power class on the market today, and is available in an IP54 enclosure.

Built-in EMC filters

VLT® HVAC Drive units are equipped with integrated DC link chokes and EMC filters as standard features. This enables them to reduce grid pollution and eliminate the cost and effort of fitting external EMC components and related wiring.

HVAC Inside

Engineered specifically for use with building automation, the VLT® HVAC Drive FC 102 features intelligent HVAC functions for pumps, fans, and compressors.

Unlike many other makes, all important components and functions are integrated as standard features:

- Built-in RFI filter compliant with EN 61800-3 category C1 (Class B limits as defined by EN 55011)
- Built-in mains interference chokes (UK 4%)
- AEO function for especially high energy savings
- USB interface
- Real time clock

- VLT® HVAC Drive in low harmonic version
- Integrated cascade controller for three fans, pumps or compressors
- Optional active and passive mains filters for additional harmonic reduction
- Optional sine-wave filter and du/dt filter for all power ratings
- RS485 serial interface
- Dimensioned for long service life
- Full mains voltage at the output
- Long motor cables may be connected (150 m shielded or 300 m unshielded)
- PTC thermistor monitoring

EC+

The intelligent VVC+ control principle enables the use of permanent magnet motors or synchronous reluctance motors with VLT® HVAC Drive, providing efficiency equal to or better than EC technology.

Danfoss has integrated the necessary control algorithm into the existing VLT® drive series. This means that there are no changes for the operator. After entering the relevant motor data, the user benefits from the high motor efficiency of EC technology.

Advantages of the EC+ concept

- Free choice of motor technology: control a SynRM, PM or induction motor with the same AC drive
- Device installation and operation remain unchanged
- Manufacturer independence in the choice of all components
- Superior system efficiency thanks to a combination of individual components with optimum efficiency
- Retrofitting of existing systems is possible
- Wide range of rated powers for SynRM, PM and induction motors.

<http://drives.danfoss.com/industries/hvac/ec-concept/>

Power range

200-240 V

208 V 6.6-172 A I_{Nr} 1.1-45 kW

230 V 6.6-170 A I_{Nr} 1.5-60 Hp

380-480 V

400 V 3-1720 A I_{Nr} 1.1-1000 kW

460 V 2.7-1530 A I_{Nr} 1.5-1350 Hp

525-600 V

575 V 2.4-131 A I_{Nr} 1.1-90 kW

575 V 2.4-131 A I_{Nr} 1.5-125 Hp

525-690 V

525 V 2.1-1479 A I_{Nr} 1.5-1550 Hp

690 V 1.6-1415 A I_{Nr} 1.1-1400 kW

Ingress protection ratings

IEC: IP00, IP20, IP21, IP54, IP55, IP66

UL: Chassis, Type 1, Type 12, Type 4X



Stand-alone drives

No need to compromise

Can't make space for a cabinet? Now there is no need. VLT® drives are so robust that you can mount them virtually anywhere, even right beside the motor. Equipped for the toughest of environments, they suit your application, no matter the requirement.

More uncompromising features:

- Enclosure types rated up to IP66/UL Type 4X
- Full EMC compliance according to international standards
- Ruggedized and coated PCBs
- Wide temperature range, operating from -25 to +50 °C without derating
- Motor cable lengths up to 150 m as standard, with uncompromised performance



Enclosed drives

Win time

VLT® drives are designed with the installer and operator in mind to save time on installation, commissioning and maintenance.

VLT® enclosed drives are designed for full access from the front. Just open the cabinet door and all components can be reached without removing the drive, even when mounted side by side.

More time-saving features:

- An intuitive user interface with an award-winning Local Control Panel (LCP) and common control platform that streamlines start-up and operating procedures
- Robust design and advanced controls make VLT® drives virtually maintenance free

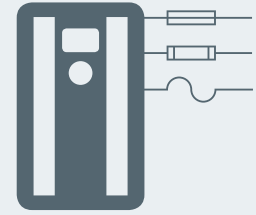

Modules

Win space

The compact design of high-power VLT® drives makes them easy to fit even in small spaces. Integrated filters, options and accessories provide additional capabilities and protection without increasing the enclosure size.

More space-saving features:

- Built-in DC link reactors for harmonic suppression eliminate the need for higher loss external AC line reactors
- Optional built-in RFI filters are available throughout the power range
- Optional input fuses and loadshare terminals are available within standard enclosures
- In addition to the many valuable features that VLT® drives offer as standard, there are numerous other control, monitoring and power options available in pre-engineered factory configurations



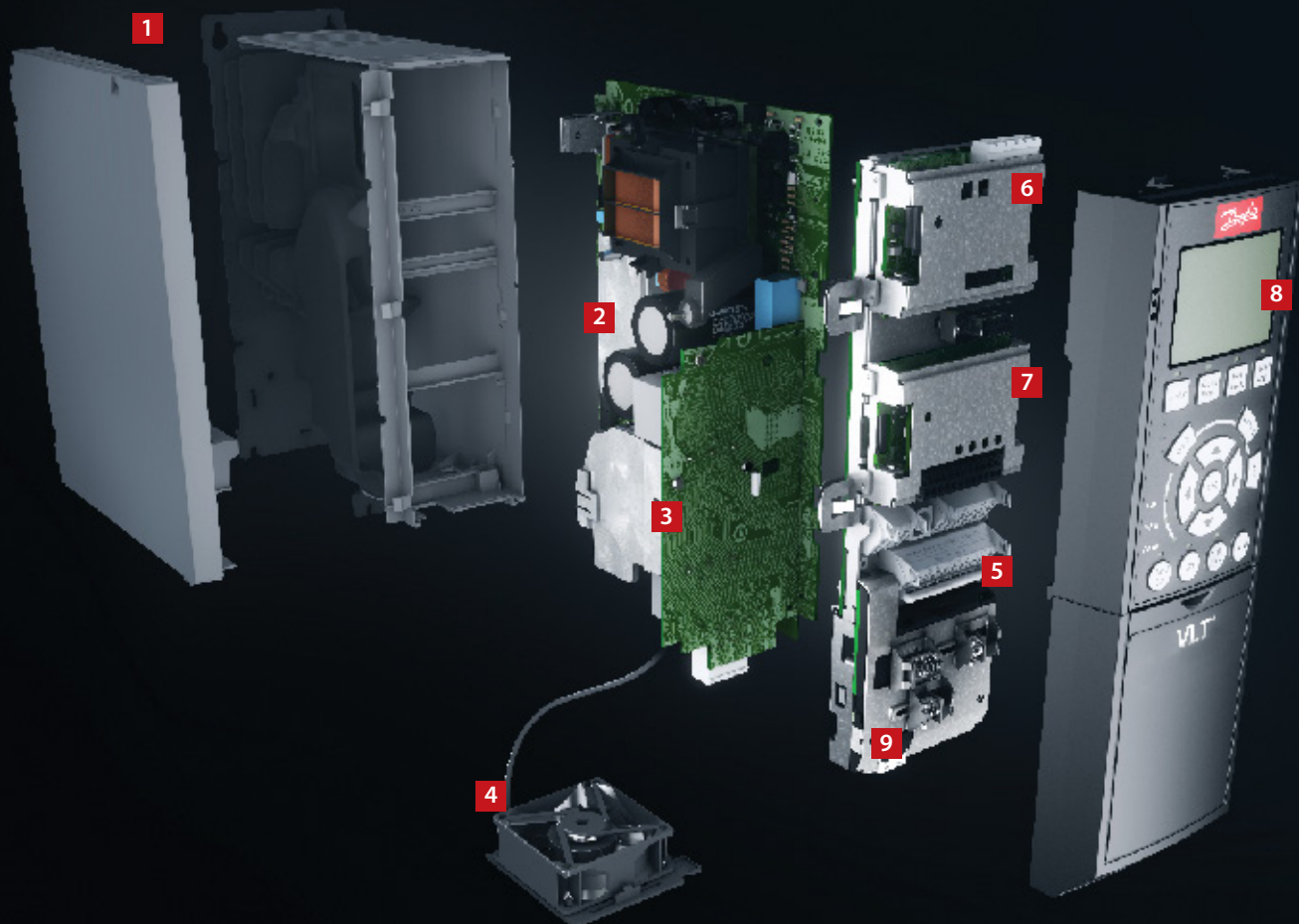

Modular simplicity – A, B and C enclosures

Delivered fully assembled and tested to meet your specific requirements

1. Enclosure

The drive meets requirements for enclosure class IP20/Chassis. IP21/UL Type 1, IP54/UL Type 12, IP55/UL Type 12 or IP66/UL Type 4X.

2. EMC and Network effects

All versions of VLT® HVAC Drive comply as standard with EMC limits B, A1 or A2 according to the EN 55011 norm and IEC61800-3 Category C1, C2 and C3. The standard integrated DC coils ensure low harmonic load on the network according to EN 61000-3-12 and increase the lifetime of the DC link capacitors.

3. Protective coating

The electronic components are, as standard, coated as per IEC 60721-3-3, class 3C2. For harsh and aggressive environments, coating as per IEC60721-3-3, class 3C3 is available.

4. Removable fan

Like most of the elements, the fan can be quickly removed and remounted for easy cleaning.

5. Control terminals

Specially developed removable spring-loaded cage clamps add to reliability and facilitate easy commissioning and service.

6. Fieldbus option

See complete list of available fieldbus options on page 41.

7. I/O options

The general purpose I/O, relay and thermistor expands the flexibility of the drives.

8. Display option

Danfoss drives' renowned removable Local Control Panel (LCP) has an improved user interface. Choose between 27 built-in languages (including Chinese) or have it customized with your own. Languages can be changed by the user.

Alternatively the drive can be commissioned via the built-in USB/RS485 connection or through fieldbus options with the VLT® Motion Control Tool MCT 10 PC tool.

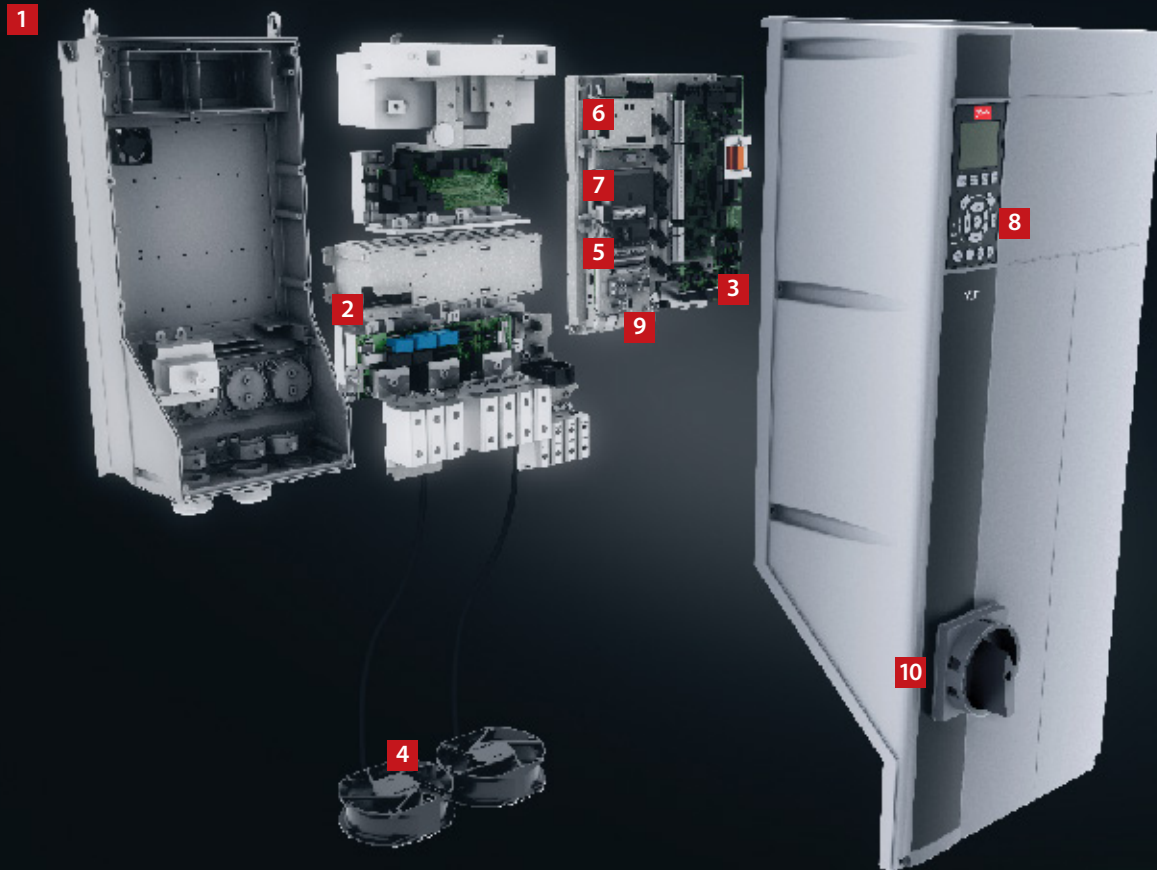

9. 24 V supply

A 24 V supply keeps the VLT® drives logically “alive” in situations when the AC power supply is removed.

10. Mains switch

This switch interrupts the mains supply and has a free useable auxiliary contact.

Safety

Please see chapter “Integrate Safely”.

Built-in Smart Logic Controller

The built-in Smart Logic Controller is a clever way to add customer-specific functionality to the drive and increase the opportunities for the drive, motor and application working together.

The controller monitors a specified event. When an event occurs, the controller performs a pre-defined action and then starts monitoring for the next pre-defined event. 20 steps of events and resulting actions are available before returning to the first set.

Logic functions can be selected; most of them run independently of the sequence control. This enables drives to monitor variables or signal defined events in an easy and flexible way independently of the motor control.

The Smart Logic Controller and four auto-tuning PID controllers can control air handling functions with fans, valves and dampers. This reduces direct digital control tasks in the building management system and frees valuable data points for other use.

High-power modularity – D, E and F enclosures

The high-power VLT® HVAC Drive modules are all built on a modular platform allowing for highly customized drives which are mass produced, tested, and delivered from the factory.

Upgrades and further options dedicated to your industry are a matter of plug-and-play. Once you know one, you know them all.

1. Display options

Danfoss drives' renowned removable Local Control Panel (LCP) has an improved user interface. Choose between 27 built-in languages (including Chinese) or have it customized with your own. Languages can be changed by the user.

2. Hot pluggable LCP

The LCP can be plugged in or unplugged during operation. Settings are easily transferred via the control panel from one drive to another or from a PC with MCT 10 set-up software.

3. Integrated manual

The info button makes the printed manual virtually redundant. Users have been involved throughout development to ensure optimum overall functionality of the drive. The user group has significantly influenced the design and functionality of the LCP.

The Automatic Motor Adaptation (AMA), the Quick Set-Up menu and the large graphic display make commissioning and operation a breeze.

4. Fieldbus options

See complete list of available fieldbus options on page 41.

5. I/O options

The general purpose I/O, relay and thermistor expands the flexibility of the drives.

6. Control terminals

Specially developed removable spring-loaded cage clamps add to reliability and facilitate easy commissioning and service.

7. 24 V supply

A 24 V supply keeps the VLT® drives logically "alive" in situations when the AC power supply is removed.

8. RFI filter suitable for IT-grids

All high-power drives come standard with RFI filtering according to EN 61800-3 Cat. C3/EN 55011 class A2. A1/C2 RFI filters according to IEC 61000 and EN 61800 standards as integrated options.

9. Modular construction and ease of maintenance

All components are easily accessible from the front of the drive, allowing for ease of maintenance and side-by-side mounting of drives. The drives are constructed using a modular design that allows for the easy replacement of modular sub-assemblies.

10. Programmable options

A freely-programmable motion control option for user-specific control algorithms and programs allows the integration of PLC programs.

11. Conformally coated and ruggedized circuit boards

All high power drive circuit boards are conformal coated to withstand the salt mist test. Meets IEC 60721-3-3 Class 3C3. The conformal coating complies with ISA (International Society of Automation) standard S71.04 1985, class G3. Additionally, drives in D- and E-enclosures can be further ruggedized to withstand the higher vibration needs of certain applications.

12. Back-channel cooling

The unique design uses a back channel to pass cooling air over heat sinks. This design allows up to 90% of the heat losses to be exhausted directly outside of the enclosure with minimal air passing through the electronics area. This reduces temperature rise and contamination of the electronic components for improved reliability and increased functional life.

As an option, the back-channel cooling duct can be supplied in stainless steel to provide a degree of corrosion resistance against conditions such as those found in salt-air environments near the ocean.

13. Enclosure

The drive meets relevant requirements for all possible installation conditions. Enclosure class IP00/chassis, IP20/chassis, IP21/UL Type 1, and IP54/UL Type 12. A kit is available to increase the enclosure class on enclosure size D drives to UL Type 3R.

14. DC-link reactor

The built-in DC-link reactor ensures low harmonic disturbance of the power supply in accordance with IEC-61000-3-12. The result is a more compact design with higher efficiencies than competitive systems with external mounted AC chokes.

15. Input mains option

Various input configurations are available, including fuses, mains disconnect switch, or RFI filter.



Efficiency is vital for high-power drives

Efficiency is essential in the design of the high-power VLT® drive series. Innovative design and exceptionally high-quality components have resulted in unsurpassed energy efficiency.

VLT® drives pass more than 98% of the supplied electrical energy on to the motor. Only 2% or less is left in the power electronics as heat to be removed.

Energy is saved and electronics last longer because they are not exposed to high temperatures within the enclosure.

Safety

Please see chapter "Integrate Safely".

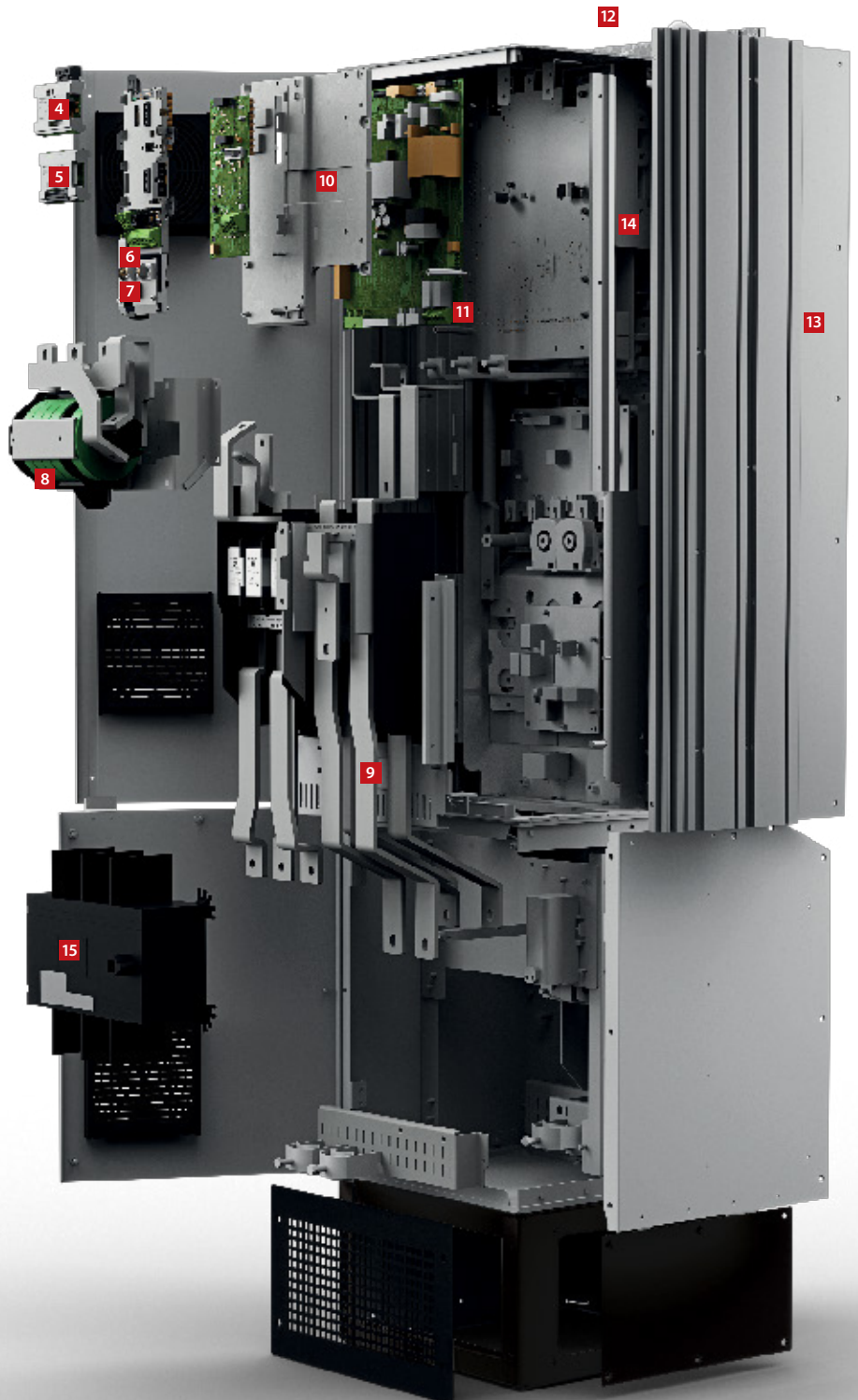

Engineered for **cost savings** via **intelligent heat management**, compactness and **protection**

All Danfoss VLT® drives follow the same design principle for fast, flexible and fault-free installation, and efficient cooling.

The AC drives are available in a broad range of enclosure sizes and protection ratings from IP20 to IP54 to enable easy installation in all environments: mounted in panels, switch rooms or as stand-alone units in the production area.

Cost saving heat management

In AC drives there is total separation between the back-channel cooling air and the internal electronics. This separation greatly reduces the airflow over the sensitive electronics, minimizing the exposure to contaminants. At the same time it removes heat efficiently which helps to prolong product life, increase the overall availability of the system

and reduce faults related to high temperatures.

For example, by exhausting heat directly outside, it is possible to reduce the size of the cooling system in the panel or switch room. This can be achieved with Danfoss' extremely efficient back-channel cooling concept, allowing heat to be vented outside the control room.

In daily use the benefits are equally clear as the energy consumption related to cooling can be reduced significantly. This means that designers can reduce the size of the air conditioning system, or even eliminate it entirely.

Coated circuit boards

The AC drive conforms as standard to class 3C3 (IEC 60721-3-3) to ensure long lifetime even in harsh environments.

Ruggedized for extra protection

The AC drive in enclosure size D is available in a 'ruggedized' version that ensures the components remain firmly in place in environments characterized by high degrees of vibration, such as marine and mobile equipment.



3C3

Coated PCBs as
standard in all high-
power drives

Back-channel cooling gives up to
90%
 reduction
 in investment for air cooling systems

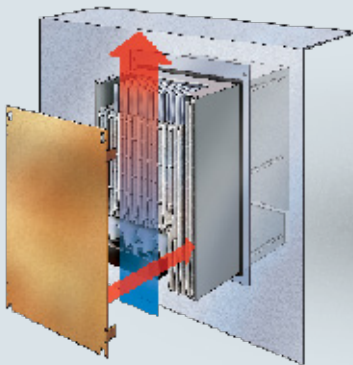
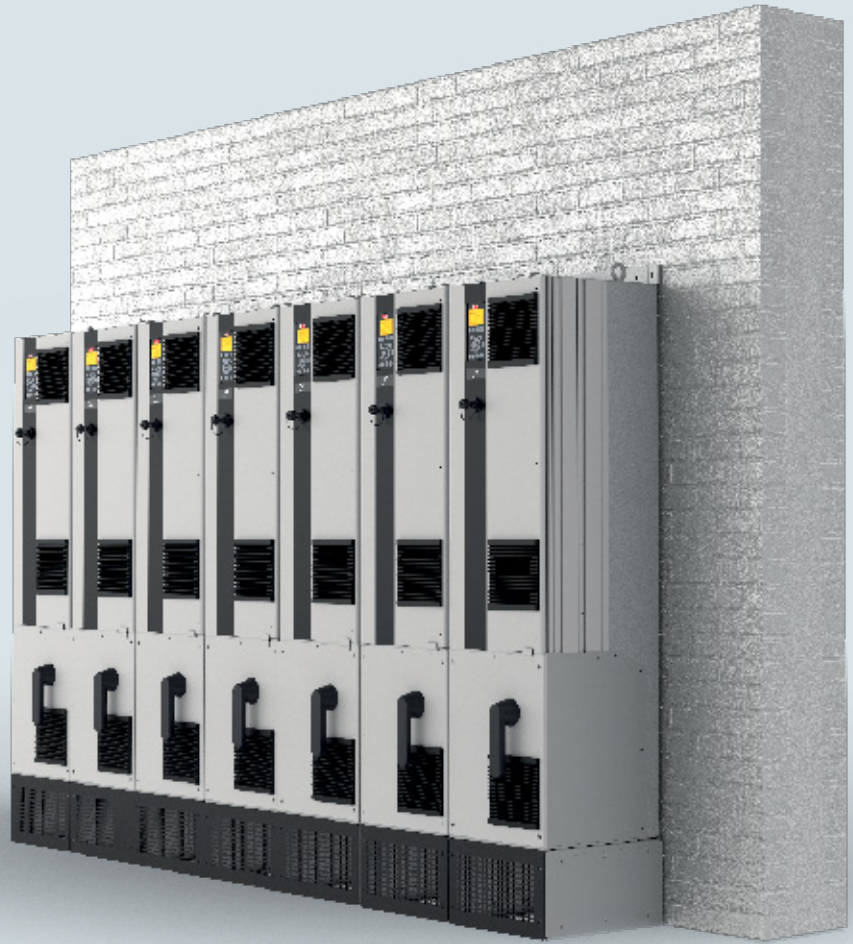

Panel through cooling

An accessory mounting kit for small and mid-range drives enables heat losses to be directed directly outside the panel room.

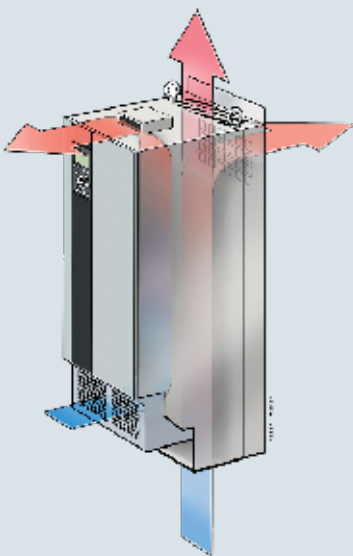

Minimal airflow over electronics

Complete separation between back-channel cooling air and the internal electronics ensures efficient cooling.

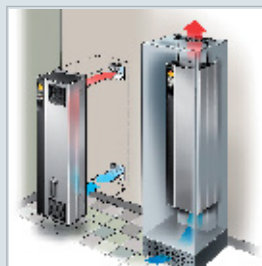

Back-channel cooling

By directing air through a rear cooling channel up to 90% of the drive's heat loss is removed directly outside the installation room.

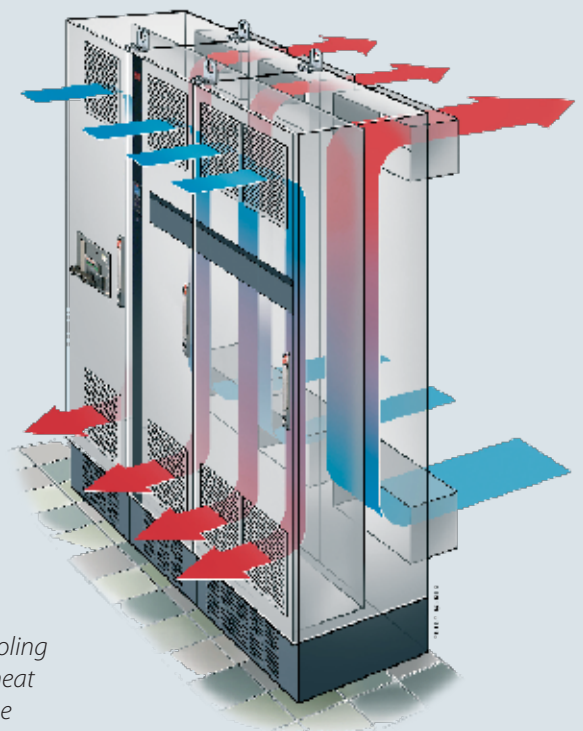

Optimize performance and grid protection

Built-in protection

The AC drive contains all the modules necessary for compliance with EMC standards.

A built-in, scalable RFI filter minimizes electromagnetic interference, and the integrated DC link chokes reduce the harmonic distortion in the mains network, in accordance with IEC 61000-3-12. Furthermore, they increase the lifetime of the DC link capacitors and therefore the overall efficiency of the drive.

These built-in components save cabinet space, as they are integrated in the drive from the factory. Efficient EMC mitigation also enables the use of cables with smaller cross-sections, which reduces installation costs.

Expand grid and motor protection with filter solutions

Danfoss' wide range of solutions for harmonic mitigation ensures a clean power supply and optimal equipment protection, and includes:

- VLT® Advanced Harmonic Filter AHF
- VLT® Advanced Active Filter AAF
- VLT® Low Harmonic Drives
- VLT® 12-pulse Drives

Provide extra motor protection with:

- VLT® Sine-wave Filter
- VLT® dU/dt Filter
- VLT® Common Mode Filters

Achieve optimum performance for your application, even where the grid is weak or unstable.

Use motor cables up to 300 m

The design of the AC drive makes it a perfect choice in applications that require long motor cables. Without needing additional components, the drive provides trouble-free operation with cable lengths of up to 150 m shielded or 300 m unshielded. This allows the drive to be installed in a central control room, away from the application without affecting motor performance.

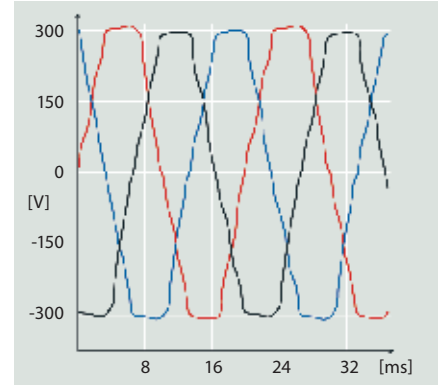

Harmonic distortion

Electrical interference reduces efficiency and risks harming equipment.

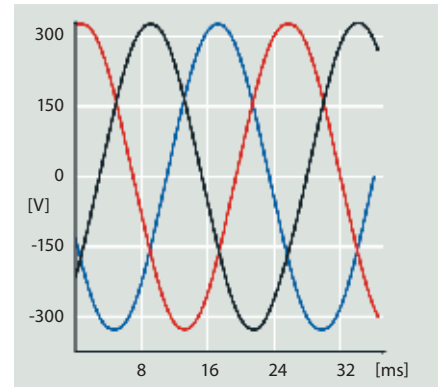

Optimized harmonic performance

Efficient harmonic mitigation protects electronics and increases efficiency.

EMC Standards		Conducted emission		
Standards and requirements	EN 55011 Facility operators must comply with EN 55011	Class B Housing and light industries	Class A Group 1 Industrial environment	Class A Group 2 Industrial environment
	EN/IEC 61800-3 Converter manufacturers must conform to EN/IEC 61800-3	Category C1 First environment, home and office	Category C2 First environment, home and office	Category C3 Second environment
Compliance ¹⁾		■	■	■

¹⁾ Compliance to mentioned EMC classes depends on the selected filter. For further details see the design guides.

You're covered with DrivePro® Life Cycle service products

Get the most out of your systems, with the help of DrivePro® services for Danfoss VLT® and VACON® drives. You get services that go beyond simple troubleshooting, maintenance, repairs and replacements. They also proactively improve productivity, performance and uptime.

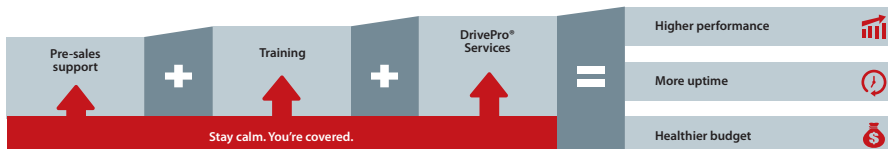
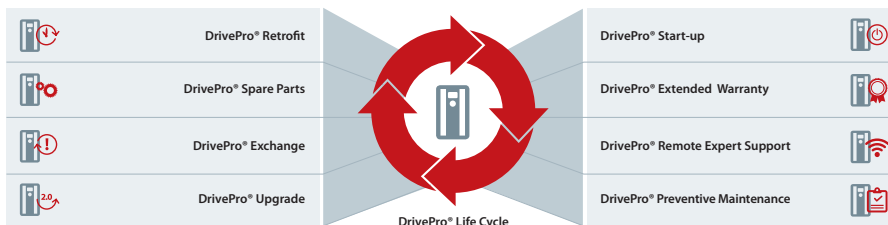

Discover more at drivepro.danfoss.com

DrivePro® app

Use the DrivePro app for fast access to the DrivePro® services, for improved productivity, performance and uptime of your systems. Find your closest service partner, place a service request, and register your VLT® and VACON® drives. You can also look up product information, specifications and manuals for your specific VLT® or VACON® drive based on the nameplate product code, or the product name.



Connection example

The numbers represent the terminals on the drive

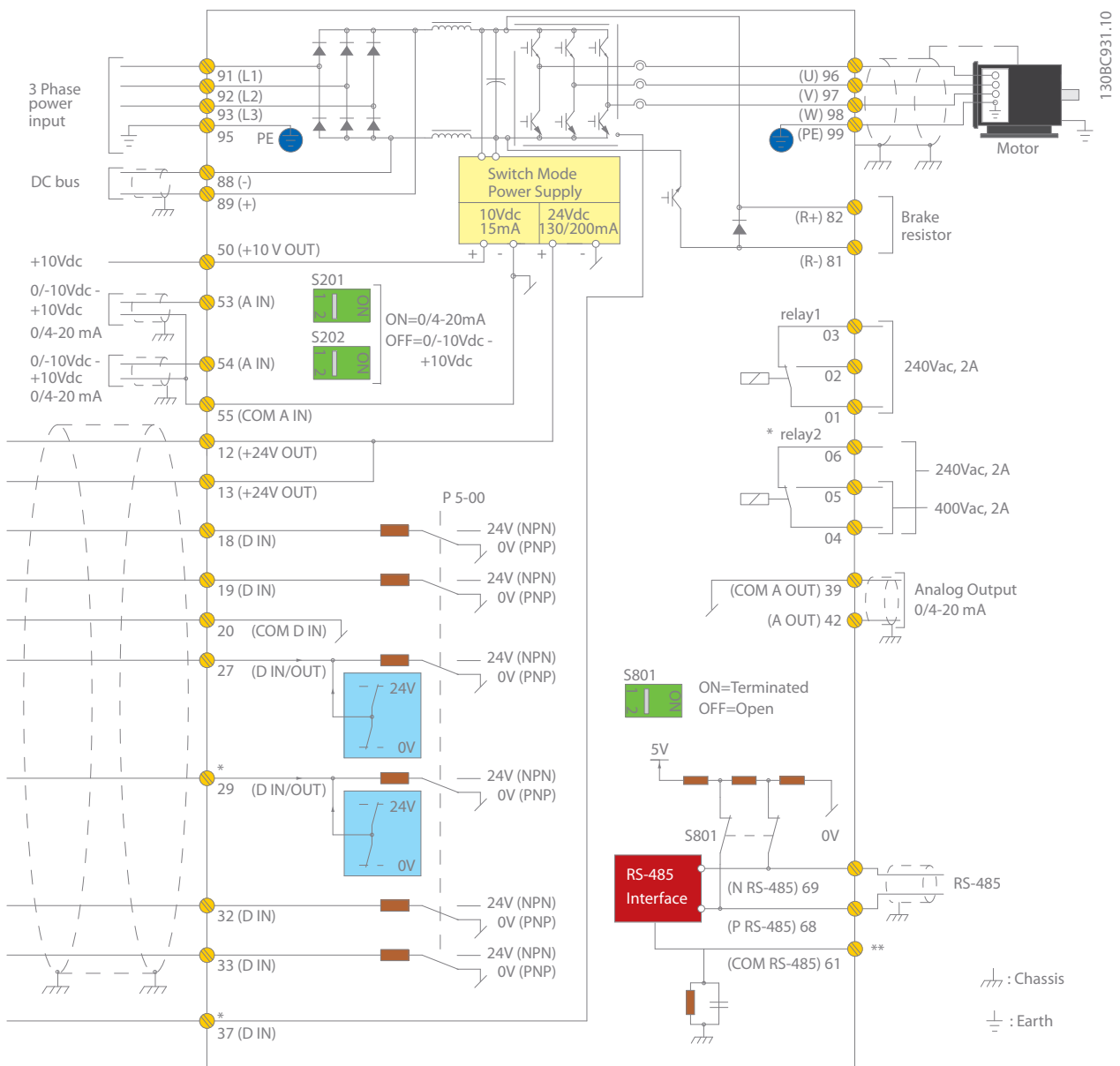

This diagram shows a typical installation of the VLT® HVAC Drive. Power is connected to the terminals 91 (L1), 92 (L2) and 93 (L3) and the motor is connected to 96 (U), 97 (V) and 98 (W).

Terminals 88 and 89 are used for load sharing between drives. Analogue inputs can be connected to the 53 (V or mA), and for 54 (V or mA) terminals.

These inputs can be set up as either reference, feedback or thermistor inputs.

There are 6 digital inputs to be connected to terminals 18, 19, 27, 29, 32, and 33. Two digital input/output terminals (27 and 29) can be set up as digital outputs to show an actual status or warning or can be used as pulse reference signal. The terminal 42 analogue output can show process values such as 0 - I_{max}.

On the 68 (P+) and 69 (N-) terminals' RS 485 interface, the drive can be controlled and monitored via serial communication.

Technical data

Basic unit without extensions

Main supply (L1, L2, L3)	
Supply voltage	200-240 V AC 380-480 V AC 525-600 V AC 525-690 V AC
Supply frequency	50/60 Hz
Displacement power factor (cos φ) near unity	> 0.98
Switching on input supply L1, L2, L3	1-2 times/min.
Output data (T1, T2, T3)	
Output voltage	0-100% of supply voltage
Output frequency	0-590 Hz
Switching on output	Unlimited
Ramp times	0.01-3600 s
Digital inputs	
Programmable digital inputs	6*
Changeable to digital output	2 (terminal 27, 29)
Logic	PNP or NPN
Voltage level	0-24 V DC
Maximum voltage on input	28 V DC
Input resistance, Ri	Approx. 4 kΩ
Scan interval	5 ms
* Two of the inputs can be used as digital outputs	
Analog inputs	
Analog inputs	2
Modes	Voltage or current
Voltage level	0 to +10 V (scaleable)
Current level	0/4 to 20 mA (scaleable)
Accuracy of analog inputs	Max. error: 0.5% of full scale
Pulse inputs	
Programmable pulse inputs	2*
Voltage level	0-24 V DC (PNP positive logic)
Pulse input accuracy (0.1-1 kHz)	Max. error: 0.1% of full scale
* Two of the digital inputs can be used for pulse inputs.	
Digital outputs	
Programmable digital/pulse outputs	2
Voltage level at digital/frequency output	0-24 V DC
Max. output current (sink or source)	40 mA
Maximum output frequency	0-32 kHz
Accuracy on frequency output	Max. error: 0.1% of full scale
Analog outputs	
Programmable analog outputs	1
Current range at analog output	0/4-20 mA
Max. load to common at analog output (clamp 30)	500 Ω
Accuracy on analog output	Max. error: 0.5% of full scale

Control card	
USB interface	1.1 (Full Speed)
USB plug	Type "B"
RS485 interface	Up to 115 kBaud
Max. load (10 V)	15 mA
Max. load (24 V)	200 mA
Relay outputs	
Programmable relay outputs	2
Max. terminal load (AC) on 1-3 (NC), 1-2 (NO), 4-6 (NC) power card	240 V AC, 2 A
Max. terminal load (AC -1) on 4-5 (NO) power card	400 V AC, 2 A
Min. terminal load on 1-3 (NC), 1-2 (NO), 4-6 (NC), 4-5 (NO) power card	24 V DC 10 mA, 24 V AC 20 mA
Surroundings/external	
Ingress protection class	IP: 00/20/21/54/55/66 UL Type: Chassis/1/12/3R/4X
Vibration test	0.7 g
Max. relative humidity	5-95% (IEC 721-3-3); Class 3K3 (non-condensing) during operation
Ambient temperature	Max. 50° C without derating
Galvanic isolation of all I/O supplies according to PELV	
Aggressive environment	Designed for 3C3 (IEC 60721-3-3)
Ambient temperature	
Operating temperature range is -25 °C to 50 °C without derating Max 55 °C with derating	
Fieldbus communication	
Standard built-in: FC Protocol N2 Metasys FLN Apogee Modbus RTU BACnet (embedded)	Optional: VLT® PROFIBUS DP V1 MCA 101 VLT® DeviceNet MCA 104 VLT® LonWorks MCA 108 VLT® BACnet MCA 109 VLT® PROFINET MCA 120 VLT® EtherNet/IP MCA 121 VLT® Modbus TCP MCA 122 VLT® BACnet/IP MCA 125
Protection mode for longest possible up-time	
Electronic motor thermal protection against overload	
Protection against overtemperature	
The AC drive is protected against short circuits on motor terminals R, S, T	
The AC drive is protected against ground faults on motor terminals U, V, W	
Protection against mains phase loss	

Agency approvals



Electrical data – A, B, and C enclosures

[T2] 3 x 208-240 V AC

Type code	Normal overload (110% 1 min/10 min)						Enclosure size			
	Output current (3 x 200-240 V)		Typical shaft output power		Continuous input current	Estimated power loss	Protection rating [IEC/UL]			
	Con. I _N	Inter. I _{MAX} (60 s)	kW @ 208 V	Hp @ 230 V			IP20	IP21	IP55	IP66
FC-102	Con. I _N	Inter. I _{MAX} (60 s)	kW @ 208 V	Hp @ 230 V	[A]	[W]	Chassis	Type 1	Type 12	Type 4X
P1K1	6.6	7.3	1.1	1.5	6.5	63	A2	A2	A4/A5	A4/A5
P1K5	7.5	8.3	1.5	2	7.5	82	A2	A2	A4/A5	A4/A5
P2K2	10.6	11.7	2.2	3	10.5	116	A2	A2	A4/A5	A4/A5
P3K0	12.5	13.8	3	4	12.4	155	A3	A3	A5	A5
P3K7	16.7	18.4	3.7	5	16.5	185	A3	A3	A5	A5
P5K5	24.2	26.6	5.5	7.5	24.2	310	B3	B1	B1	B1
P7K5	30.8	33.9	7.5	10	30.8	310	B3	B1	B1	B1
P11K	46.2	50.8	11	15	46.2	514	B3	B1	B1	B1
P15K	59.4	65.3	15	20	59.4	602	B4	B2	B2	B2
P18K	74.8	82.3	18.5	25	74.8	737	B4	C1	C1	C1
P22K	88	96.8	22	30	88	845	C3	C1	C1	C1
P30K	115	127	30	40	114	1140	C3	C1	C1	C1
P37K	143	157	37	50	143	1353	C4	C2	C2	C2
P45K	170	187	45	60	169	1636	C4	C2	C2	C2

[T4] 3 x 380-480 V AC

Type code	Normal overload (110% 1 min/10 min)							Enclosure size				
	Output current				Typical shaft output power		Continuous input current	Estimated power loss	Protection rating [IEC/UL]			
	(3 x 380-440 V)		(3 x 441-480 V)		kW @ 400 V	Hp @ 460 V			IP20	IP21	IP55	IP66
FC-102	Con. I _N	Inter. I _{MAX} (60 s)	Con. I _N	Inter. I _{MAX} (60 s)			kW @ 400 V	Hp @ 460 V	[A]	[W]	Chassis	Type 1
P1K1	3	3.3	2.7	3	1.1	1.5	3	58	A2	A2	A4/A5	A4/A5
P1K5	4.1	4.5	3.4	3.7	1.5	2	4.1	62	A2	A2	A4/A5	A4/A5
P2K2	5.6	6.2	4.8	5.3	2.2	3	5.5	88	A2	A2	A4/A5	A4/A5
P3K0	7.2	7.9	6.3	6.9	3	4	7.2	116	A2	A2	A4/A5	A4/A5
P4K0	10	11	8.2	9	4	5	9.9	124	A2	A2	A4/A5	A4/A5
P5K5	13	14.3	11	12.1	5.5	7.5	12.9	187	A3	A3	A5	A5
P7K5	16	17.6	14.5	16	7.5	10	15.8	225	A3	A3	A5	A5
P11K	24	26.4	21	23.1	11	15	24.2	392	B3	B1	B1	B1
P15K	32	35.2	27	29.7	15	20	31.9	392	B3	B1	B1	B1
P18K	37.5	41.3	34	37.4	18.5	25	37.4	465	B3	B1	B1	B1
P22K	44	48.4	40	44	22	30	44	525	B4	B2	B2	B2
P30K	61	67.1	52	61.6	30	40	60.5	739	B4	B2	B2	B2
P37K	73	80.3	65	71.5	37	50	72.6	698	B4	C1	C1	C1
P45K	90	99	80	88	45	60	90.2	843	C3	C1	C1	C1
P55K	106	117	105	116	55	75	106	1083	C3	C1	C1	C1
P75K	147	162	130	143	75	100	146	1384	C4	C2	C2	C2
P90K	177	195	160	176	90	125	177	1474	C4	C2	C2	C2

[T6] 3 x 525-600 V AC

Normal overload (110% 1 min/10 min)							Enclosure size			
Type code	Output current (3 x 525-600 V)		Typical shaft output power		Intermittent input current [A]	Estimated power loss [W]	Protection rating [IEC/UL]			
	Con. I _N	Inter. I _{MAX} (60 s)	kW @ 575 V	Hp @ 575 V			IP20	IP21	IP55	IP66
FC-102	Con. I _N	Inter. I _{MAX} (60 s)	kW @ 575 V	Hp @ 575 V	[A]	[W]	Chassis	Type 1	Type 12	Type 4X
P1K1	2.4	2.6	1.1	1.5	2.6	50	A3	A3	A5	A5
P1K5	2.7	3	1.5	2	3	65	A3	A3	A5	A5
P2K2	3.9	4.3	2.2	3	4.5	92	A3	A3	A5	A5
P3K0	4.9	5.4	3	4	5.7	122	A2	A2	A5	A5
P4K0	6.1	6.7	4	5	6.4	145	A2	A2	A5	A5
P5K5	9	9.9	5.5	7.5	9.5	195	A3	A3	A5	A5
P7K5	11	12.1	7.5	10	11.4	261	A3	A3	A5	A5
P11K	18	20	11	15	19	300	B3	B1	B1	B1
P15K	22	24	15	20	23	300	B3	B1	B1	B1
P18K	27	30	18.5	25	28	370	B3	B1	B1	B1
P22K	34	37	22	30	36	440	B4	B2	B2	B2
P30K	41	45	30	40	43	600	B4	B2	B2	B2
P37K	52	57	37	50	54	740	B4	C1	C1	C1
P45K	62	68	45	60	65	900	C3	C1	C1	C1
P55K	83	91	55	75	87	1100	C3	C1	C1	C1
P75K	100	110	75	100	105	1500	C4	C2	C2	C2
P90K	131	144	90	125	137	1800	C4	C2	C2	C2

[T7] 3 x 525-690 V AC

Normal overload (110% 1 min/10 min)								Enclosure size			
Type code	Output current				Typical shaft output power		Continuous input current [A]	Estimated power loss [W]	Protection rating [IEC/UL]		
	(3 x 525-550 V)		(3 x 551-690 V)		kW @ 690 V	Hp @ 575 V			IP20	IP21	IP55
FC-102	Con. I _N	Inter. I _{MAX} (60 s)	Con. I _N	Inter. I _{MAX} (60 s)	kW @ 690 V	Hp @ 575 V	[A]	[W]	Chassis	Type 1	Type 12
P1K1	2.1	2.3	1.6	1.8	1.1	1.5	2.1	44	A3	A3	A5
P1K5	2.7	3	2.2	2.4	1.5	2	2.6	60	A3	A3	A5
P2K2	3.9	4.3	3.2	3.5	2.2	3	3.9	88	A3	A3	A5
P3K0	4.9	5.4	4.5	5	3	4	4.8	120	A3	A3	A5
P4K0	6.1	6.7	5.5	6.1	4	5	6.1	160	A3	A3	A5
P5K5	9	9.9	7.5	8.3	5.5	7.5	8.9	220	A3	A3	A5
P7K5	11	12.1	10	11	7.5	10	10.9	300	A3	A3	A5
P11K	14	15.4	13	14.3	11	15	16.5	220	B4	B2	B2
P15K	19	20.9	18	19.8	15	20	21.5	220	B4	B2	B2
P18K	23	25.3	22	24.2	18.5	25	26.4	300	B4	B2	B2
P22K	28	30.8	27	29.7	22	30	31.9	370	B4	B2	B2
P30K	36	39.6	34	37.4	30	40	39.6	440	B4	B2	B2
P37K	43	47.3	41	45.1	37	50	53.9	740	B4	C2	C2
P45K	54	59.4	52	57.2	45	60	64.9	900	C3	C2	C2
P55K	65	71.5	62	68.2	55	75	78.1	1100	C3	C2	C2
P75K	87	95.7	83	91.3	75	100	95.7	1500	-	C2	C2
P90K	105	115.5	100	110	90	125	108.9	1800	-	C2	C2

Dimensions enclosure sizes A, B and C

Enclosure size		VLT® HVAC Drive													
		A2		A3		A4	A5	B1	B2	B3	B4	C1	C2	C3	C4
Protection rating [IEC/UL]		IP20 Chassis	IP21 Type 1	IP20 Chassis	IP21 Type 1	IP55/Type 12 IP66/Type 4X	IP21/Type 1 IP55/Type 12 IP66/Type 4X	IP00/Chassis	IP00/Chassis	IP00/Chassis	IP21/Type 1 IP55/Type 12 IP66/Type 4X	IP21/Type 1 IP55/Type 12 IP66/Type 4X	IP00/Chassis	IP00/Chassis	
[mm]	Height	268	375	268	375	390	420	480	650	399	520	680	770	550	660
	Height with decoupling plate	374	-	374	-	-	-	-	-	420	595	-	-	630	800
	Width	90	90	130	130	200	242	242	242	165	230	308	370	308	370
	Width with one C option	130	130	170	170	-	242	242	242	205	230	308	370	308	370
	Depth	205	207	205	207	175	200	260	260	249	242	310	335	333	333
	Depth with A, B option	220	222	220	222	175	200	260	260	262	242	310	335	333	333
	Depth with mains disconnect	-	-	-	-	206	224	289	290	-	-	344	378	-	-
[kg]	Weight	4.9	5.3	6	7	9.7	14.2	23	27	12	23.5	45	64	35	50
[in]	Height	10.6	14.8	10.6	14.8	15.4	16.6	18.9	25.6	15.8	20.5	26.8	30.4	21.7	26
	Height with decoupling plate	14.8	-	14.8	-	-	-	-	-	16.6	23.5	-	-	24.8	31.5
	Width	3.6	3.6	5.2	5.2	7.9	9.6	9.6	9.6	6.5	9.1	12.2	14.6	12.2	14.6
	Width with one C option	5.2	5.2	6.7	6.7	-	9.6	9.6	9.6	8.1	9.1	12.2	14.6	12.2	14.6
	Depth	8.1	18.2	8.1	8.2	6.9	7.9	10.3	10.3	9.8	9.6	12.3	13.2	13	13
	Depth with mains disconnect	-	-	-	-	8.2	8.9	11.4	11.5	-	-	13.6	14.9	-	-
	Depth with A, B option	8.7	8.8	8.7	8.8	6.9	7.9	10.3	10.3	10.4	9.6	12.3	13.2	13	13
[lb]	Weight	10.8	11.7	14.6	15.5	21.5	31.5	50.7	59.6	26.5	52	99.3	143.3	77.2	110.2

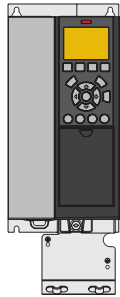

A3 IP20/Chassis with decoupling plate

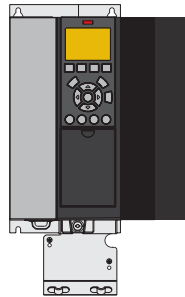

A3 IP20 with option C

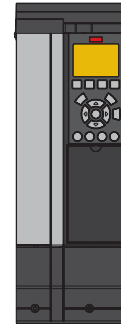

A3 with IP21/Type 12 NEMA 1 Kit



A4 IP55 with mains disconnect

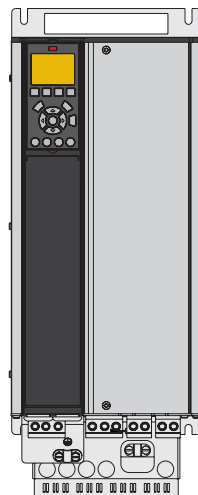

B4 IP20

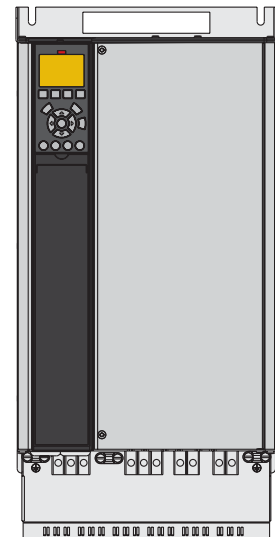

C3 IP20

Ordering typecode for A, B and C enclosures

[1]	[2]	[3]	[4]	[5]	[6]	[7]	[8]	[9]	[10]	[11]	[12]	[13]	[14]	[15]	[16]	[17]	[18]	[19]
FC-															CX		XX	

[1] Application (character 4-6)

102	VLT® HVAC Drive FC 102
-----	------------------------

[2] Power size (character 7-10)

P1K1	1.1 kW / 1.5 Hp
P1K5	1.5 kW / 2.0 Hp
P2K2	2.2 kW / 3.0 Hp
P3K0	3.0 kW / 4.0 Hp
P3K7	3.7 kW / 5.0 Hp
P4K0	4.0 kW / 5.5 Hp
P5K5	5.5 kW / 7.5 Hp
P7K5	7.5 kW / 10 Hp
P11K	11 kW / 15 Hp
P15K	15 kW / 20 Hp
P18K	18.5 kW / 25 Hp
P22K	22 kW / 30 Hp
P30K	30 kW / 40 Hp
P37K	37 kW / 50 Hp
P45K	45 kW / 60 Hp
P55K	55 kW / 75 Hp
P75K	75 kW / 100 Hp
P90K	90 kW / 125 Hp
N75K	75 kW / 100 Hp
N90K	90 kW / 125 Hp

[3] AC Line Voltage (character 11-12)

T2	3 x 200-240 V AC
T4	3 x 380-480 V AC
T6	3 x 525-600 V AC
T7	3 x 525-690 V AC

[4] IP/UL protection ratings (character 13-15)

IP20/Chassis enclosures

E20	IP20/Chassis
P20	IP20/Chassis + backplate

IP21/UL Type 1 enclosures

E21	IP21/Type 1
P21	IP21/Type 1 + backplate

IP55/UL Type 12 enclosures

E55	IP55/Type 12
P55	IP55/Type 12 + backplate
Y55	IP55/Type 12 + backplate (A4 enclosure, no C-options)
Z55	IP55/Type 12 (A4 enclosure, no C-options)

UL Type 3R enclosures

E3R	UL Type 3R (North America only)
P3R	UL Type 3R + backplate (North America only)

IP66/UL Type 4X enclosures

E66	IP66/Type 4X
Y66	IP66/Type 4X + backplate (A4 enclosure, no C-options)
Z66	IP66/Type 4X (A4 enclosure, no C-options)

[5] RFI filter, terminal and monitoring options – EN/IEC 61800-3 (character 16-17)

H1	RFI-Filter Class A1/B (C1)
H2	RFI-Filter, Class A2 (C3)
H3	RFI-Filter Class A1/B ¹⁾
H4	RFI-Filter, Class A1 (C2)
H5	RFI-Filter, Class A2 (C3) Marine ruggedized
HX	No RFI-Filter

[6] Braking and safety (character 18)

X	No brake IGBT
B	Brake IGBT
T	Safe Stop without brake
U	Brake IGBT plus Safe Stop

[7] LCP Display (character 19)

X	Blank faceplate, no LCP installed
N	Numerical Local Control Panel (LCP 101)
G	Graphical Local Control Panel (LCP 102)

[8] PCB Coating – IEC 721-3-3 (character 20)

X	Standard coated PCB Class 3C2
C	Coated PCB Class 3C3

[9] Mains input (character 21)

X	No mains option
1	Mains disconnect (A4, A5, B1, B2, C1 and C2 enclosures only)
8	Mains disconnect and load sharing (B1, B2, C1 and C2 enclosures only)
D	Load sharing terminals (B1, B2, C1, C2 enclosures only)

[10] Hardware option A (character 22)

X	Standard cable entries
O	Metric cable entry (threaded)
S	Imperial cable entry

[11] Hardware option B (character 23)

X	No adaptation
---	---------------

[12] Special version (character 24-27)

SXXX	Latest released standard software
------	-----------------------------------

[13] LCP language (character 28)

X	Standard language package including English, German, French, Spanish, Danish, Italian, Finnish and others
---	---

Contact factory for other language options

[14] A-options: Fieldbus (character 29-30)

AX	No option
A0	VLT® PROFIBUS DP V1 MCA 101
A4	VLT® DeviceNet MCA 104
AG	VLT® LonWorks MCA 108
AJ	VLT® BACnet MCA 109
AL	VLT® PROFINET MCA 120
AN	VLT® EtherNet/IP MCA 121
AQ	VLT® Modbus TCP MCA 122
AK	VLT® BACnet/IP MCA 125

[15] B-options (character 31-32)

BX	No option
BK	VLT® General Purpose MCB 101
BP	VLT® Relay Option MCB 105
B0	VLT® Analog I/O Option MCB 109
B2	VLT® PTC Thermistor Card MCB 112
B4	VLT® Sensor Input Card MCB 114

[16] C0-option (character 33-34)

CX	No option
----	-----------

[17] C1-option (character 35-36)

X	No C1-option
R	VLT® Extended Relay Card MCB 113

[19] Control Power Backup Input (character 38-39)

DX	No DC input installed
D0	VLT® 24 V DC Supply Option MCB 107

1) reduced motor cable length
Please beware that not all combinations are possible. Find help configuring your drive with the online configurator found under: driveconfig.danfoss.com

Electrical data – D, E and F enclosures

[T4] 3 x 380-480 V AC

Type code	Normal overload (110% 1 min/10 min)								Enclosure size		
	Output current				Typical shaft output power		Continuous input current	Estimated power loss	Protection rating [IEC/UL]		
	(3 x 380-440 V)		(3 x 441-480 V)						IP20	IP21	IP54
FC-102	Con. I _N	Inter. I _{MAX} (60 s)	Con. I _N	Inter. I _{MAX} (60 s)	kW @ 400 V	Hp @ 460 V	[A]	[W]	Chassis	Type 1	Type 12
N110	212	233	190	209	110	150	204	2559	D3h	D1h/D5h/D6h	
N132	260	286	240	264	132	200	251	2954	D3h	D1h/D5h/D6h	
N160	315	347	302	332	160	250	304	3770	D3h	D1h/D5h/D6h	
N200	395	435	361	397	200	300	381	4116	D4h	D2h/D7h/D8h	
N250	480	528	443	487	250	350	463	5137	D4h	D2h/D7h/D8h	
N315	588	647	535	588	315	450	567	6674	D4h	D2h/D7h/D8h	
N355	658	724	590	649	355	500	634	6928	E3h	E1h	E1h
N400	745	820	678	746	400	600	718	8036	E3h	E1h	E1h
N450	800	880	730	803	450	600	771	8783	E3h	E1h	E1h
N500	880	968	780	858	500	650	848	9473	E4h	E2h	E2h
N560	990	1089	890	979	560	750	954	11102	E4h	E2h	E2h
P500	880	968	780	858	500	650	857	10162	–	F1/F3	F1/F3
P560	990	1089	890	979	560	750	964	11822	–	F1/F3	F1/F3
P630	1120	1232	1050	1155	630	900	1090	12512	–	F1/F3	F1/F3
P710	1260	1386	1160	1276	710	1000	1227	14674	–	F1/F3	F1/F3
P800	1460	1606	1380	1518	800	1200	1422	17293	–	F2/F4	F2/F4
P1M0	1720	1892	1530	1683	1000	1350	1675	19278	–	F2/F4	F2/F4

[T7] 3 x 525-690 V AC

Type code	Normal overload (110% 1 min/10 min)								Enclosure size		
	Output current				Typical shaft output power		Continuous input current	Estimated power loss	Protection rating [IEC/UL]		
	(3 x 525-550 V)		(3 x 551-690 V)						IP20	IP21	IP54
FC-102	Con. I _N	Inter. I _{MAX} (60 s)	Con. I _N	Inter. I _{MAX} (60 s)	kW @ 690 V	Hp @ 575 V	[A]	[W]	Chassis	Type 1	Type 12
N75K	90	99	86	95	75	75	89	1162	D3h	D1h/D5h/D6h	
N90K	113	124	108	119	90	100	110	1428	D3h	D1h/D5h/D6h	
N110K	137	151	131	144	110	125	130	1740	D3h	D1h/D5h/D6h	
N132	162	178	155	171	132	150	158	2101	D3h	D1h/D5h/D6h	
N160	201	221	192	211	160	200	198	2649	D3h	D1h/D5h/D6h	
N200	253	278	242	266	200	250	245	3074	D4h	D2h/D7h/D8h	
N250	303	333	290	319	250	300	299	3723	D4h	D2h/D7h/D8h	
N315	360	396	344	378	315	350	355	4465	D4h	D2h/D7h/D8h	
P400	418	460	400	440	400	400	408	5028	D4h	D2h/D7h/D8h	
N450	470	517	450	495	450	450	434	6062	E3h	E1h	E1h
N500	523	575	500	550	500	500	482	6879	E3h	E1h	E1h
N560	596	656	570	627	560	600	549	8076	E3h	E1h	E1h
N630	630	693	630	693	630	650	607	9208	E3h	E1h	E1h
N710	763	839	730	803	710	750	704	10346	E4h	E2h	E2h
N800	889	978	850	935	800	950	819	12723	E4h	E2h	E2h
P710	763	839	730	803	710	750	743	9212	–	F1/ F3	F1/ F3
P800	889	978	850	935	800	950	866	10659	–	F1/ F3	F1/ F3
P900	988	1087	945	1040	900	1050	962	12080	–	F1/ F3	F1/ F3
P1M0	1108	1219	1060	1166	1000	1150	1079	13305	–	F2/ F4	F2/ F4
P1M2	1317	1449	1260	1386	1200	1350	1282	15865	–	F2/ F4	F2/ F4
P1M4	1479	1627	1415	1557	1400	1550	1440	18173	–	F2/ F4	F2/ F4

Dimensions enclosure size D

		VLT® HVAC Drive									
Enclosure size		D1h	D2h	D3h	D3h ⁽¹⁾	D4h	D4h ⁽¹⁾	D5h ⁽²⁾	D6h ⁽³⁾	D7h ⁽⁴⁾	D8h ⁽⁵⁾
Protection rating [IEC/UL]		IP21 /Type 1 IP54 /Type 12		IP20 /Chassis				IP21 /Type 1 IP54 /Type 12			
[mm]	Height	901.0	1107.0	909.0	1026.5	1122.0	1293.8	1324.0	1663.0	1978.0	2284.0
	Width	325.0	420.0	250.0	250.0	350.0	350.0	325.0	325.0	420.0	420.0
	Depth	378.4	378.4	375.0	375.0	375.0	375.0	381.0	381.0	386.0	406.0
[kg]	Weight	62.0	125.0	62.0	108.0	125.0	179.0	99.0	128.0	185.0	232.0
[in]	Height	35.5	43.6	35.8	39.6	44.2	50.0	52.1	65.5	77.9	89.9
	Width	12.8	12.8	19.8	9.9	14.8	13.8	12.8	12.8	16.5	16.5
	Depth	14.9	14.9	14.8	14.8	14.8	14.8	15.0	15.0	15.2	16.0
[lb]	Weight	136.7	275.6	136.7	238.1	275.6	394.6	218.3	282.2	407.9	511.5

⁽¹⁾ dimensions with regeneration or load share terminals

⁽²⁾ D5h is used with disconnect and/or brake chopper options

⁽³⁾ D6h is used with contactor and/or circuit breaker options

⁽⁴⁾ D7h is used with disconnect and/or brake chopper options

⁽⁵⁾ D8h is used with contactor and/or circuit breaker options

Dimensions enclosure sizes E and F

		VLT® HVAC Drive							
Frame		E1h	E2h	E3h	E4h	F1	F2	F3	F4
Protection rating [IEC/UL]		IP21 /Type 1 IP54 /Type 12		IP20 /Chassis IP21 /Type 1		IP21 /Type 1 IP54 /Type 12			
[mm]	Height	2043.0	2043.0	1578.0	1578.0	2204.0	2204.0	2204.0	2204.0
	Width	602.0	698.0	506.0	604.0	1400.0	1800.0	2000.0	2400.0
	Depth	513.0	513.0	482.0	482.0	606.0	606.0	606.0	606.0
[kg]	Weight	295.0	318.0	272.0	295.0	1017.0	1260.0	1318.0	1561.0
[in]	Height	80.4	80.4	62.1	62.1	86.8	86.8	86.8	86.8
	Width	23.7	27.5	199.9	23.9	55.2	70.9	78.8	94.5
	Depth	20.2	20.2	19.0	19.0	23.9	23.9	23.9	23.9
[lb]	Weight	650.0	700.0	600.0	650.0	2242.1	2777.9	2905.7	3441.5

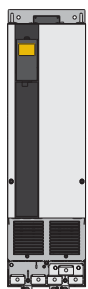

D3h/D4h

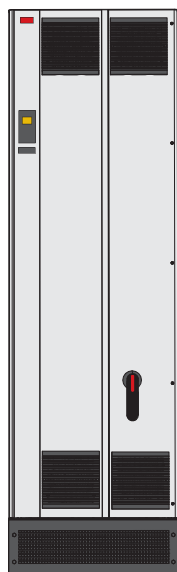

E1h



F

Electrical data and dimensions – VLT® 12-Pulse

[T4] 6 x 380-480 V AC

Type code	Normal overload (110% 1 min/10 min)								Enclosure size			
	Output current				Typical shaft output power		Continuous input current	Estimated power loss	Protection rating [IEC/UL]			
	(3 x 380-440 V)		(3 x 441-480 V)						IP21/Type 1		IP54/Type 12	
FC-102	Con. I _N	Inter. I _{MAX} (60 s)	Con. I _N	Inter. I _{MAX} (60 s)	kW @ 400 V	Hp @ 460 V	[A]	[W]	AC drive	+ options	AC drive	+ options
P315	600	660	540	594	315	450	590	6790	F8	F9	F8	F9
P355	658	724	590	649	355	500	647	7701	F8	F9	F8	F9
P400	745	820	678	746	400	600	733	8879	F8	F9	F8	F9
P450	800	880	730	803	450	600	787	9670	F8	F9	F8	F9
P500	880	968	780	858	500	650	857	10647	F10	F11	F10	F11
P560	990	1089	890	979	560	750	964	12338	F10	F11	F10	F11
P630	1120	1232	1050	1155	630	900	1090	13201	F10	F11	F10	F11
P710	1260	1386	1160	1276	710	1000	1227	15436	F10	F11	F10	F11
P800	1460	1606	1380	1518	800	1200	1422	18084	F12	F13	F12	F13
P1M0	1720	1892	1530	1683	1000	1350	1675	20358	F12	F13	F12	F13

[T7] 6 x 525-690 V AC

Type code	Normal overload (110% 1 min/10 min)								Enclosure size			
	Output current				Typical shaft output power		Continuous input current	Estimated power loss	Protection rating [IEC/UL]			
	(3 x 525-550 V)		(3 x 551-690 V)						IP21/Type 1		IP54/Type 12	
FC-102	Con. I _N	Inter. I _{MAX} (60 s)	Con. I _N	Inter. I _{MAX} (60 s)	kW @ 690 V	Hp @ 575 V	[A]	[W]	AC drive	+ options	AC drive	+ options
P450	470	517	450	495	450	450	453	5529	F8	F9	F8	F9
P500	523	575	500	550	500	500	504	6239	F8	F9	F8	F9
P560	596	656	570	627	560	600	574	7653	F8	F9	F8	F9
P630	630	693	630	693	630	650	607	8495	F8	F9	F8	F9
P710	763	839	730	803	710	750	743	9863	F10	F11	F10	F11
P800	889	978	850	935	800	950	866	11304	F10	F11	F10	F11
P900	988	1087	945	1040	900	1050	962	12798	F10	F11	F10	F11
P1M0	1108	1219	1060	1166	1000	1150	1079	13801	F12	F13	F12	F13
P1M2	1317	1449	1260	1386	1200	1350	1282	16821	F12	F13	F12	F13
P1M4	1479	1627	1415	1557	1400	1550	1440	19247	F12	F13	F12	F13

Dimensions enclosure size F

Enclosure size		VLT® HVAC Drive					
		F8	F9	F10	F11	F12	F13
Protection rating [IEC/UL]		IP21/Type 1 IP54/Type 12					
[mm]	Height	2204.0	2204.0	2204.0	2204.0	2204.0	2204.0
	Width	800.0	1400.0	1600.0	2400.0	2000.0	2800.0
	Depth	606.0	606.0	606.0	606.0	606.0	606.0
[kg]	Weight	447.0	669.0	893.0	1116.0	1037.0	1259.0
[in]	Height	86.8	86.8	86.8	86.8	86.8	86.8
	Width	31.5	55.2	63.0	94.5	78.8	110.2
	Depth	23.9	23.9	23.9	23.9	23.9	23.9
[lb]	Weight	985.5	1474.9	1968.8	2460.4	2286.4	2775.7

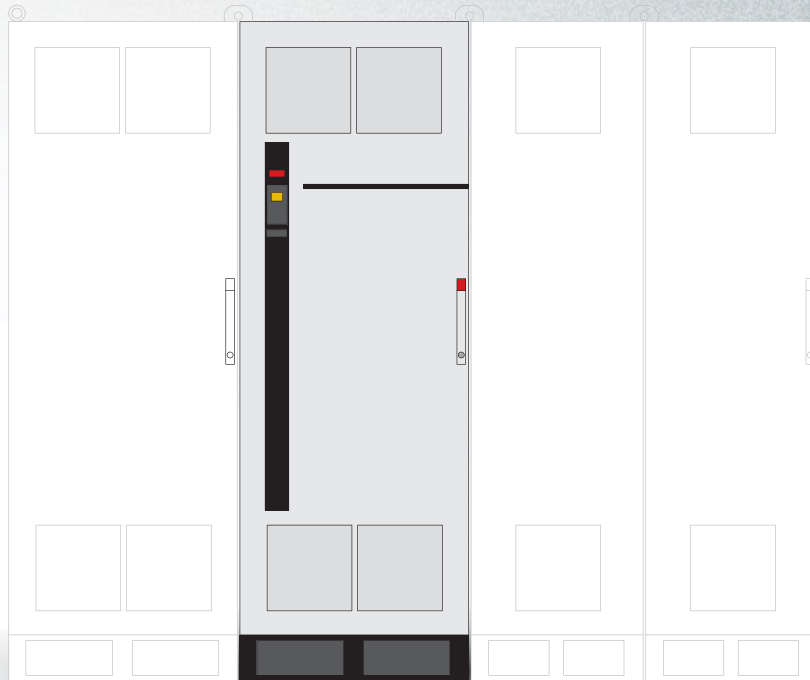

VLT® 12-pulse

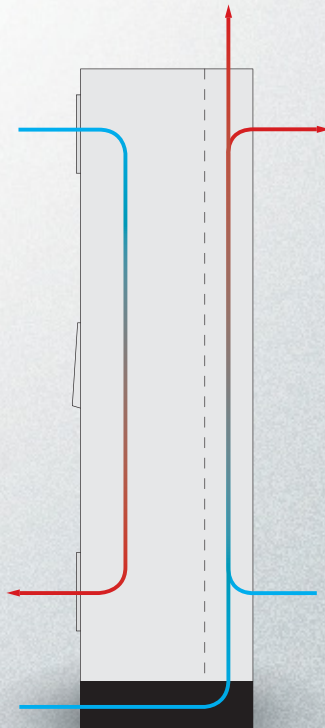

VLT® 12-pulse

Electrical data – VLT® Low Harmonic Drive and VLT® Advanced Active Filters

[T4] 3 x 480 V AC – VLT® Low Harmonic Drive

Type code	Normal overload (110% 1 min/10 min)								Enclosure size	
	Output current				Typical shaft output power		Continuous input current	Estimated power loss	Protection rating [IEC/UL]	
	(3 x 380-440 V)		(3 x 441-480 V)						IP21	IP54
FC-102	Con. I _N	Inter. I _{MAX} (60 s)	Con. I _N	Inter. I _{MAX} (60 s)	kW @ 400 V	Hp @ 460 V	[A]	[W]	Type 1	Type 12
N132	315	347	302	332	160	250	304	8725	D1n	D1n
N160	395	435	361	397	200	300	381	9831	D2n	D2n
N200	480	528	443	487	250	350	463	11371	D2n	D2n
N250	600	660	540	594	315	450	590	14051	E9	E9
P315	658	724	590	649	355	500	647	15320	E9	E9
P355	745	820	678	746	400	600	733	17180	E9	E9
P400	800	880	730	803	450	600	787	18447	E9	E9

[T4] 3 x 380-480 V AC VLT® Advanced Active Filter

Type code	Normal overload (110% 1 min/10min automatically regulated)									Enclosure size		
	Corrected Current								Recommended fuse and disconnect*	Estimated power loss	Protection rating [IEC/UL]	
	@ 400 V		@ 460 V		@ 480 V		@ 500 V				IP21	IP54
AAF006	Cont.	Int.	Cont.	Int.	Cont.	Int.	Cont.	Int.	[A]	[W]	Type 1	Type 12
A190	260	390	240	360	260	390	240	360	350	5000	D14	D14
A250	315	473	302	453	315	473	302	453	630	7000	E1	E1
A310	395	593	361	542	395	593	361	542	630	9000	E1	E1
A400	480	720	443	665	480	720	443	665	900	11100	E1	E1

* Built-in options for fuses and disconnect recommended

Dimensions – VLT® Low Harmonic Drive and VLT® Advanced Active Filter

		VLT® Low Harmonic Drive			VLT® Advanced Active Filter	
Enclosure size		D1n	D2n	E9	D14	E1
Protection rating [IEC/UL]		IP21/Type 1 IP54/Type 12			IP21/Type 1 IP54/Type 12	
[mm]	Height	1915.91	1914.7	2000.7	1780.0	2000.0
	Width	929.2	1024.2	1200.0	600.0	600.0
	Depth	418.4	418.4	538.0	418.4	538.0
[kg]	Weight	353.0	413.0	676.0	238.0	453.0
[in]	Height	75.4	75.4	78.8	70.0	78.7
	Width	36.6	40.3	47.2	23.6	23.6
	Depth	16.5	16.5	21.0	16.5	21.0
[lb]	Weight	777.0	910.0	1490.0	524.7	998.7

Specifications VLT® Advanced Active Filter

Filter type	3P/3W, Active Shunt Filter (TN, TT, IT)
Frequency	50 to 60 Hz, ± 5%
Enclosures	IP 21 – NEMA 1, IP 54 – NEMA 12
Max. voltage pre-distortion	10% 20% with reduced performance
Operating temperature	0-40° C +5° C with reduced performance -10° C with reduced performance
Altitude	1000 m without derating 3000 m with reduced performance (5%/1000 m)
EMC standards	IEC61000-6-2 IEC61000-6-4
Circuitry coating	Conformal coated – per ISA S71.04-1985, class G3
Languages	18 different
Harmonic compensation modes	Selective or overall (90% RMS for harmonic reduction)
Harmonic compensation spectrum	2 nd to 40 th in overall mode, including triplens 5 th , 7 th , 11 th , 13 th , 17 th , 19 th , 23 rd , 25 th in selective mode

Individual harmonic current allocation in selective mode	I5: 63%, I7: 45%, I11: 29%, I13: 25%, I17: 18%, I19: 16%, I23: 14%, I25: 13%
Reactive current compensation	Yes, leading (capacitive) or lagging (inductive) to target power factor
Flicker reduction	Yes
Compensation priority	Programmable to harmonics or displacement power factor
Paralleling option	Up to 4 units of same power rating in master follower
Current Transformer Support (Customer supply and field mounting)	1 A and 5 A secondary with auto tuning Class 0.5 or better
Digital inputs /outputs	4 (2 programmable) Programmable PNP or NPN logic
Communication interface	RS485, USB1.1
Control type	Direct harmonic control (for faster response)
Response time	< 15 ms (including HW)
Harmonic settling time (5-95%)	< 15 ms
Reactive settling time (5-95%)	< 15 ms
Maximum overshoot	5%
Switching frequency	Progressive control in the range of 3 – 18 kHz
Average switching frequency	3 – 4.5 kHz



VLT® Advanced Active Filter AAF 006

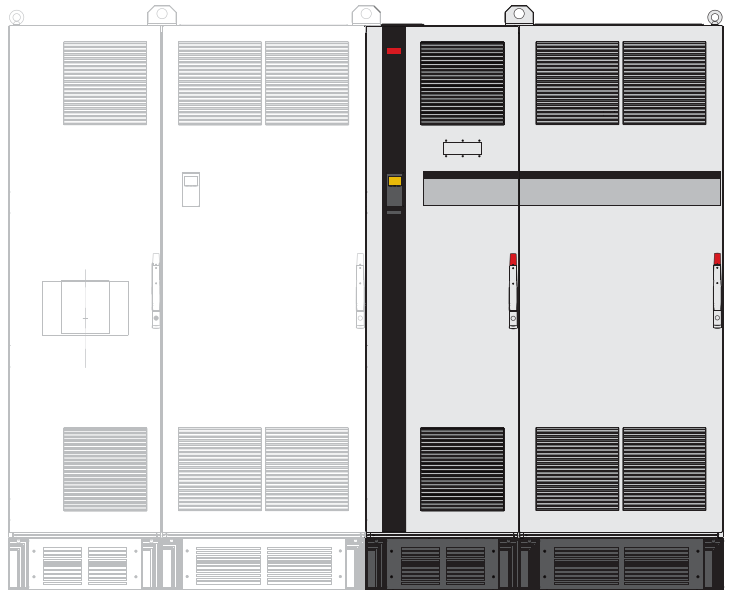

VLT® Low Harmonic Drive

Typecode VLT® Advanced Active Filter

The different VLT® Active Filters can easily be configured according to customer request at drives.danfoss.com

1	2	3	4	5	6	7	8	9	10	11	12	13	14	15	16	17	18	19	20	21	22	23	24	..	39
A	A	F	0	0	6	A	x	x	x	T	4	E	x	x	H	x	x	G	C	x	x	x	S	.	X
8-10: 190: 190 A correction current 250: 250 A correction current 310: 310 A correction current 400: 400 A correction current				13-15: E21: IP 21/NEMA 1 E2M: IP 21/NEMA 1 w. mains shield C2M: IP 21/NEMA 1 w. stainless steel back-channel and mains shield				E54: IP 54/NEMA 12 E5M: IP 54/NEMA 12 w. mains shield C5M: IP 54/NEMA 12 w. stainless steel back-channel and mains shield				16-17: HX: No RFI Filter H4: RFI class A1				21: X: No mains options 3: Disconnect & Fuse 7: Fuse									



A options: Fieldbuses

Available for the full product range

Fieldbus	Typecode position
A	
VLT® PROFIBUS DP MCA 101	14
VLT® DeviceNet MCA 104	
VLT® LonWorks MCA 108	
VLT® BACnet MCA 109	
VLT® PROFINET MCA 120	
VLT® EtherNet/IP MCA 121	
VLT® Modbus TCP MCA 122	
VLT® BACnet/IP MCA 125	

PROFIBUS DP

Operating the AC drive via a fieldbus enables you to reduce the cost of your system, communicate faster and more efficiently and benefit from an easier user interface.

Other features:

- Wide compatibility, a high level of availability, support for all major PLC vendors, and compatibility with future versions
- Fast, efficient communication, transparent installation, advanced diagnosis and parameterization and auto-configuration of process data via GSD-file
- Acyclic parameterization using PROFIBUS DP-V1, PROFIdrive or Danfoss FC (MCA101 only) profile state machines, PROFIBUS DP-V1, Master Class 1 and 2

VLT® PROFIBUS DP MCA 101

Order code

130B1100 standard
130B1200 coated

DeviceNet

DeviceNet offers robust, efficient data handling thanks to advanced Producer/Consumer technology.

- Support of ODVA's AC drive profile supported via I/O instance 20/70 and 21/71 secures compatibility to existing systems
- Benefit from ODVA's strong conformance testing policies, which ensure that products are interoperable

VLT® DeviceNet MCA 104

Order code

130B1102 standard
130B1202 coated

LonWorks

LonWorks is a fieldbus system developed for building automation. It enables communication between individual units in the same system (peer-to-peer) and thus supports decentralizing of control.

- No need for main station (master-follower)
- Supports echelon free-topology interface
- Supports embedded I/O and I/O options
- Sensor signals can quickly be moved to another controller via bus cables
- Certified as compliant with LonMark ver. 3.4 specifications (VLT® LonWorks MCA 108 only)

VLT® LonWorks MCA 108

Order code

130B1106 standard
130B1206 coated

BACnet MS/TP

The BACnet protocol is an international protocol that efficiently integrates all parts of building automation equipment from the actuator level to the building management system.

Via the BACnet option, it is possible to read all analog and digital inputs and control all analog and digital outputs of the VLT® HVAC Drive and VACON® NX5.

All inputs and outputs can be operated independently of the functions of the drive, and thus work as remote I/O:

Other features:

- COV (Change of Value)
- Synchronization of RTC from BACnet
- Read/write property multiple
- Alarm/warning handling

VLT® BACnet MCA 109

Order code

130B1144 standard
130B1244 coated

PROFINET

PROFINET uniquely combines the highest performance with the highest degree of openness. The option is designed so that many of the features from the PROFIBUS can be reused, minimizing user effort to migrate PROFINET and securing the investment in a PLC program.

- Same PPO types as PROFIBUS for easy migration to PROFINET
- Support of MRP
- Support of DP-V1 Diagnostic allows easy, fast and standardized handling of warning and fault information into the PLC, improving bandwidth in the system
- Implementation in accordance with Conformance Class B

VLT® PROFINET MCA 120

Order code

130B1135 standard, dual-port
130B1235 coated, dual-port

EtherNet/IP

Ethernet is the future standard for communication at the factory floor. EtherNet/IP is based on the newest technology available for industrial use and handles even the most demanding requirements.

EtherNet/IP™ extends commercial off-the-shelf Ethernet to the Common Industrial Protocol (CIP™) – the same upper-layer protocol and object model found in DeviceNet.

The option offers advanced features such as:

- Built-in high performance switch enabling line-topology, and eliminating the need for external switches
- DLR Ring
- Advanced switch and diagnosis functions
- Built-in web server
- E-mail client for service notification
- Unicast and Multicast communication

VLT® EtherNet/IP MCA 121

Order code

130B1119 standard, dual-port
130B1219 coated, dual-port

Modbus TCP

Modbus TCP is the first industrial Ethernet-based protocol for automation. Modbus TCP is able to handle connection intervals down to 5 ms in both directions, positioning it among the fastest performing Modbus TCP devices in the market. For master redundancy, it features hot swapping between two masters.

Other features:

- Dual Master PLC connection for redundancy in dual port options (MCA 122 only)

VLT® Modbus TCP MCA 122

Order code

130B1196 standard, dual-port
130B1296 coated, dual-port

BACnet/IP

The BACnet/IP option optimizes the use of VLT® HVAC Drive together with building management systems (BMS) using the BACnet/IP protocol or running BACnet on Ethernet. BACnet/IP makes it easy to control or to monitor points required in typical HVAC applications, reducing overall cost of ownership.

Other features:

- COV, Change Of Value
- Read/WritePropertyMultiple
- Alarm/Warning notifications
- PID Loop object
- Segmented data transfer
- Trend Objects
- Schedule Objects

VLT® BACnet/IP MCA 125

Order code

134B1586 coated, dual-port

B options: Functional extensions

Available for the full product range

Functional extensions	Typecode position
B	
VLT® General Purpose MCB 101	15
VLT® Relay Option MCB 105	
VLT® Analog I/O Option MCB 109	
VLT® PTC Thermistor Card MCB 112	
VLT® Sensor Input Card MCB 114	
VLT® Safety Option MCB 140	

VLT® General Purpose I/O MCB 101

This I/O option offers an extended number of control inputs and outputs:

- 3 digital inputs 0-24 V: Logic '0' < 5 V; Logic '1' > 10V
- 2 analog inputs 0-10 V: Resolution 10 bit plus sign
- 2 digital outputs NPN/PNP push pull
- 1 analog output 0/4-20 mA
- Spring-loaded connection

Ordering number

130B1125 standard
130B1212 coated (Class 3C3/IEC 60721-3-3)

VLT® Relay Card MCB 105

Makes it possible to extend relay functions with 3 additional relay outputs.

- Max. switch rate at rated load/min. load 6 min⁻¹/20 sec⁻¹
- Protects control cable connection
- Spring-loaded control wire connection

Max. terminal load:

- AC-1 Resistive load 240 V AC 2 A
- AC-15 Inductive load @cos phi 0.4 240 V AC 0.2 A
- DC-1 Resistive load 24 V DC 1 A
- DC-13 Inductive load @cos phi 0.4 24 V DC 0.1 A

Min. terminal load:

- DC 5 V 10 mA

Ordering number

130B1110 standard
130B1210 coated (Class 3C3/IEC 60721-3-3)

VLT® Analog I/O Option MCB 109

This analog input/output option is easily fitted in the AC drive for upgrading to advanced performance and control using the additional I/O. This option also upgrades the AC drive with a battery back-up supply for the AC drive built-in clock. This provides stable use of all AC drive clock functions as timed actions.

- 3 analog inputs, each configurable as both voltage and temperature input
- Connection of 0-10 V analog signals as well as Pt1000 and Ni1000 temperature inputs
- 3 analog outputs each configurable as 0-10 V outputs
- Back-up supply for the standard clock function in the AC drive

The back-up battery typically lasts for 10 years, depending on environment.

Ordering number

130B1143 standard
130B1243 coated (Class 3C3/IEC 60721-3-3)

VLT® PTC Thermistor Card MCB 112

The VLT® PTC Thermistor Card MCB 112 enables improved surveillance of the motor condition compared to the built-in ETR function and thermistor terminal.

- Protects the motor from overheating
- ATEX-approved for use with Ex d and Ex e motors (EX e only FC 302)
- Uses Safe Stop function, which is approved in accordance with SIL 2 IEC 61508

Ordering number

NA standard
130B1137 coated (Class 3C3/IEC 60721-3-3)

VLT® Sensor Input Card MCB 114

This option protects the motor from being overheated by monitoring the temperature of bearings and windings in the motor.

- Protects the motor from overheating
- 3 self-detecting sensor inputs for 2 or 3 wire PT100/PT1000 sensors
- 1 additional analog input 4-20 mA

Ordering number

130B1172 standard
130B1272 coated (Class 3C3/IEC 60721-3-3)

VLT® Safety Option MCB 140 and MCB 141

VLT® Safety Option MCB 140 and MCB 141 comprise safety options with Safe Stop 1 (SS1), Safely Limited Speed (SLS) and Safe Speed Monitor (SSM) functionality.

The options can be used up to PL e according to ISO 13849-1.

MCB 140 is a standard B-Option. MCB 141 offers the same functionality in an external 45 mm housing. MCB 141 enables the user to use MCB 140 functionality also if another B-Option is used.

Different operating modes can be configured easily by using the on board display and buttons. The options provide only a limited set of parameters for fast parameterization.

- MCB 140 standard B-Option
- MCB 141 external option
- Single-channel or dual-channel operation possible
- Proximity switch as speed feedback
- SS1, SLS and SMS functionality
- Easy and fast parameterization

Ordering number

130B6443 MCB 140, 130B6447 MCB 141

C options: Motion control and relay card

Available for the full product range

Motion control and relay card	Typecode position
C	
VLT® Extended Relay Card MCB 113	17

VLT® Extended Relay Card MCB 113

The VLT® Extended Relay Card MCB 113 adds inputs/outputs for increased flexibility.

- 7 digital inputs
- 2 analog outputs
- 4 SPDT relays
- Meets NAMUR recommendations

- Galvanic isolation capability
- Support is added in FW 17A for the MCO 301 option
- Allows customers to move PLC functionality found in AHU systems, for example, to the HVAC Drive

Ordering number

130B1164 standard
130B1264 coated (Class 3C3/IEC 60721-3-3)

D option: 24 V back-up power supply

Available for the full product range

24 V back-up power supply	Typecode position
D	
VLT® 24 V DC Supply Option MCB 107	19

VLT® 24 V DC Supply MCB 107

Connect an external DC supply to keep the control section and any installed option functioning during power failure.

This enables full operation of the LCP (including the parameter setting) and all installed options without connection to mains.

- Input voltage range.....24 V DC +/- 15% (max. 37 V for 10 sec.)
- Max. input current2.2 A
- Max. cable length75 m
- Input capacitance load < 10 uF
- Power-up delay < 0.6 s

Ordering number

130B1108 standard
130B1208 coated (Class 3C3/IEC 60721-3-3)



Accessories

Available for the full product range

LCP

VLT® Control Panel LCP 101 (Numeric)

Ordering number: 130B1124

VLT® Control Panel LCP 102 (Graphical)

Ordering number: 130B1107

VLT® Wireless Communication Panel LCP 103

Ordering number: 134B0460

LCP Panel Mounting Kit

Ordering number for IP20 enclosure

130B1113: With fasteners, gasket, graphical LCP and 3 m cable

130B1114: With fasteners, gasket, numerical LCP and 3 m cable

130B1117: With fasteners, gasket and without LCP and with 3 m cable

130B1170: With fasteners, gasket and without LCP

Ordering number for IP55 enclosure

130B1129: With fasteners, gasket, blind cover and 8 m "free end" cable

LCP Remote Mounting Kit

Ordering number:

134B5223 – Kit with 3 m cable:

134B5224 – Kit with 5 m cable

134B5225 – Kit with 10 m cable

Accessories

PROFIBUS SUB-D9 Adapter

IP20, A2 and A3

Ordering number: 130B1112

Option Adapter

Ordering number: 130B1130 standard, 130B1230 coated

Adapter Plate for VLT® 3000 and VLT® 5000

Ordering number: 130B0524 – to be used only for IP20/NEMA type 1 units up to 7.5 kW

USB Extension

Ordering number:

130B1155: 350 mm cable

130B1156: 650 mm cable

IP21/Type 1 (NEMA 1) kit

Ordering number

130B1121: For enclosure size size A1

130B1122: For enclosure size size A2

130B1123: For enclosure size size A3

130B1187: For enclosure size size B3

130B1189: For enclosure size size B4

130B1191: For enclosure size size C3

130B1193: For enclosure size size C4

NEMA 3R outdoor weather shield

Ordering number

176F6302: For enclosure size size D1h

176F6303: For enclosure size size D2h

NEMA 4X outdoor weather shield

Ordering number

130B4598: For enclosure size size A4, A5, B1, B2

130B4597: For enclosure size size C1, C2

Motor connector

Ordering number:

130B1065: enclosure size A2 to A5 (10 pieces)

Mains connector

Ordering number:

130B1066: 10 pieces mains connectors IP55

130B1067: 10 pieces mains connectors IP20/21

Relays 1 terminal

Ordering number: 130B1069 (10 pieces 3 pole connectors for relay 01)

Relays 2 terminal

Ordering number: 130B1068 (10 pieces 3 pole connectors for relay 02)

Control card terminals

Ordering number: 130B0295

VLT® Leakage Current Monitor Module RCMB20/RCMB35

Ordering number:

130B5645: A2-A3

130B5764: B3

130B5765: B4

130B6226: C3

130B5647: C4

VLT® Pressure Transmitter PTU 025

Ordering number:

134B5925

PC software

VLT® Motion Control Tool MCT 10

VLT® Motion Control Tool MCT 31

Danfoss HCS

VLT® Energy Box

Danfoss ecoSmart™



Power options

Power option

VLT® Sine-Wave Filter MCC 101

VLT® dU/dt Filter MCC 102

VLT® Common Mode Filters MCC 105

VLT® Advanced Harmonic Filter AHF 005/010

VLT® Brake Resistors MCE 101

VLT® Line Reactor MCC 103

VLT® Sine-wave Filter MCC 101

- VLT® Sine-wave Filters are positioned between the AC drive and the motor to provide a sinusoidal phase-to-phase motor voltage
- Reduces motor insulation stress
- Reduces acoustic noise from the motor
- Reduces bearing currents (especially in large motors)
- Reduces losses in the motor Prolongs service lifetime
- VLT® FC series family look

Power range

3 x 200-500 V, 2.5-800 A

3 x 525-690 V, 4.5-660 A

Enclosure ratings

- IP00 and IP20 wall-mounted enclosures rated up to 75 A (500 V) or 45 A (690 V)
- IP23 floor-mounted enclosures rated 115 A (500 V) or 76 A (690 V) or more
- IP54 both wall-mounted and floor-mounted enclosures rated up to 4.5 A, 10 A, 22 A (690 V)

Ordering number

See relevant Design Guide

VLT® dU/dt Filter MCC 102

- Reduces the dU/dt values on the motor terminal phase-to-phase voltage
- Positioned between the AC drive and the motor to eliminate very fast voltage changes
- The motor terminal phase-to-phase voltage is still pulse shaped but its dU/dt values are reduced
- Reduces stress on the motor's insulation and are recommended in applications with older motors, aggressive environments or frequent braking which cause increased DC link voltage
- VLT® FC series family look

Power range

3 x 200-690 V (up to 880 A)

Enclosure ratings

- IP00 and IP20/IP23 enclosure in the entire power range
- IP54 enclosure available up to 177 A

Ordering number

See relevant Design Guide

VLT® Common Mode Filter MCC 105

- Positioned between the AC drive and the motor
- They are nano-crystalline cores that mitigate high frequency noise in the motor cable (shielded or unshielded) and reduce bearing currents in the motor
- Extends motor bearing lifetime
- Can be combined with dU/dt and sine-wave filters
- Reduces radiated emissions from the motor cable
- Reduces electromagnetic interference
- Easy to install – no adjustments necessary
- Oval shaped – allows mounting inside the AC drive enclosure or motor terminal box

Power range

380-415 V AC (50 and 60 Hz)

440-480 V AC (60 Hz)

600 V AC (60 Hz)

500-690 V AC (50 Hz)

Ordering number

130B3257 Enclosure size A and B

130B7679 Enclosure size C1

130B3258 Enclosure size C2, C3 and C4

130B3259 Enclosure size D

130B3260 Enclosure size E and F

VLT® Advanced Harmonic Filter AHF 005 and AHF 010

- Optimized harmonic performance for VLT® drives rated up to 250 kW
- A patented technique reduces THD levels in the mains network to less than 5-10%
- Perfect match for industrial automation, highly dynamic applications and safety installations

Power range

380-415 V AC (50 and 60 Hz)

440-480 V AC (60 Hz)

600 V AC (60 Hz)

500-690 V AC (50 Hz)

Enclosure ratings

- IP20
(An IP21/NEMA 1 upgrade kit is available)

Ordering number

See relevant Design Guide

VLT® Brake Resistor MCE 101

- Energy generated during braking is absorbed by the resistors, protecting electrical components from heating up
- Optimized for the FC-series and general versions for horizontal and vertical motion are available
- Built-in thermo switch
- Versions for vertical and horizontal mounting
- A selection of the vertically mounted units are UL-recognized

Power range

Precision electrical match to each individual VLT® drive power size

Enclosure ratings:

- IP20
- IP21
- IP54
- IP65

Ordering number

See relevant Design Guide

VLT® Line Reactor MCC 103

- Ensures current balance in load-sharing applications, where the DC-side of the rectifier of multiple drives is connected together
- UL-recognized for applications using load sharing
- When planning load-sharing applications, pay special attention to different enclosure type combinations and inrush concepts
- For technical advice regarding load-sharing applications, contact Danfoss application support
- Compatible with VLT® HVAC Drive 50 Hz or 60 Hz mains supply

Ordering number

See relevant Design Guide



Accessory compatibility with enclosure size

Overview for enclosure sizes D, E and F only

Enclosure size	Typecode position	D1h/D2h	D3h/D4h	D5h/D7h	D6h/D8h	D1n/D2n	E1h/E2h	E3h/E4h	E9	F1/F2	F3/F4 (w/options cabinet)	F8	F9 (w/options cabinet)	F10/F12	F11/F13 (w/options cabinet)
Enclosure with corrosion-resistant back channel	4	-	□	-	-	-	□	□	-	□	□	-	-	-	-
Mains shielding	4	□	-	□	□	□	□	-	□	■	■	■	■	■	■
Space heaters and thermostat	4	□	-	□	□	-	□	-	-	□	□	-	-	□	□
Cabinet light with power outlet	4	-	-	-	-	-	-	-	-	□	□	-	-	□	□
RFI filters ^(*)	5	□	□	□	□	□	□	□	□	-	□	-	□	-	□
Insulation Resistance Monitor (IRM)	5	-	-	-	-	-	-	-	-	-	□	-	□	-	□
Residual Current Device (RCD)	5	-	-	-	-	-	-	-	-	-	□	-	□	-	□
Brake Chopper (IGBTs)	6	-	□	□	□	□	□	□	□	□	□	□	□	□	□
Safe Torque Off with Pilz Safety Relay	6	□	□	□	□	□	□	□	□	□	□	□	□	□	□
Regeneration terminals	6	-	□	□	□	□	□	□	□	□	□	□	□	□	□
Common Motor Terminals	6	■	■	■	■	■	■	■	■	□	□	■	■	□	□
Emergency Stop with Pilz Safety Relay	6	-	-	-	-	-	-	-	-	-	□	-	-	-	-
Safe Torque Off + Pilz Safety Relay	6	-	-	-	-	-	-	-	-	□	□	□	□	□	□
No LCP	7	□	□	□	□	-	□	□	-	-	-	-	-	-	-
VLТ* Control Panel LCP 101 (Numeric)	7	□	□	□	□	-	-	-	-	-	-	-	-	-	-
VLТ* Control Panel LCP 102 (Graphical)	7	□	□	□	□	■	■	■	■	■	■	■	■	■	■
Fuses	9	□	□	□	-	□	■	□	□	□	□	□	□	□	□
Load sharing terminals	9	-	□	-	-	-	-	□	-	□	□	-	-	-	-
Fuses + load sharing terminals	9	-	□	-	-	-	-	□	-	□	□	-	-	-	-
Disconnect	9 ⁽¹⁾	-	-	□	□	□	□	-	□	-	□	-	□	-	□
Circuit breakers	9 ⁽¹⁾	-	-	-	□	-	-	-	-	-	□	-	-	-	-
Contactors	9 ⁽¹⁾	-	-	-	□	-	-	-	-	-	□	-	-	-	-
Manual motor starters	10	-	-	-	-	-	-	-	-	□	□	-	-	□	□
30 A, fuse-protected terminals	10	-	-	-	-	-	-	-	-	□	□	-	-	□	□
24V DC supply	11	-	-	-	-	-	-	-	-	□	□	-	-	□	□
External temperature monitoring	11	-	-	-	-	-	-	-	-	□	□	-	-	□	□
Heat sink access panel	11	□	□	□	□	-	□	□	-	-	-	-	-	-	-
NEMA 3R ready drive	11	□	-	-	-	-	-	-	-	-	-	-	-	-	-

⁽¹⁾ Options supplied with fuses

^(*) Not available in 690 V

□ Optional

■ Standard

Enclosure with corrosion-resistant back channel

For additional protection from corrosion in harsh environments, units can be ordered in an enclosure that includes a stainless steel back channel, heavier plated heat sinks and an upgraded fan. This option is recommended in salt-air environments, such as those near the ocean.

Mains shielding

Lexan® shielding can be mounted in front of incoming power terminals and input plate to protect from accidental contact when the enclosure door is open.

Space heaters and thermostat

Mounted in the cabinet interior of drives with enclosure sizes D and F and controlled via an automatic thermostat, space heaters controlled via an automatic thermostat prevent condensation inside the enclosure.

The thermostat default settings turn on the heaters at 10°C (50° F) and turn them off at 15.6°C (60° F).

Cabinet light with power outlet

A light can be mounted on the cabinet interior of drives with enclosure size F, to increase visibility during servicing and maintenance. The light housing includes a power outlet for temporarily powering laptop computers or other devices. Available in two voltages:

- 230 V, 50 Hz, 2.5 A, CE/ENEC
- 120 V, 60 Hz, 5 A, UL/cUL

RFI filters

VLT® Series drives feature integrated Class A2 RFI filters as standard. If additional levels of RFI/EMC protection are required, they can be obtained using optional Class A1 RFI filters, which provide suppression of radio frequency interference and electromagnetic radiation in accordance with EN 55011.

On drives with enclosure size F, the Class A1 RFI filter requires the addition of the options cabinet. Marine use RFI filters are also available.

Insulation Resistance Monitor (IRM)

Monitors the insulation resistance in ungrounded systems (IT systems in IEC terminology) between the system phase conductors and ground. There is an ohmic pre-warning and a main alarm setpoint for the insulation level. Associated with each setpoint is an SPDT alarm relay for external use. Only one insulation resistance monitor can be connected to each ungrounded (IT) system.

- Integrated into the drive's safe-stop circuit
- LCD display of insulation resistance
- Fault memory
- INFO, TEST and RESET key

Residual Current Device (RCD)

Uses the core balance method to monitor ground fault currents in grounded and high-resistance grounded systems (TN and TT systems in IEC terminology). There is a pre-warning (50% of main alarm setpoint) and a main alarm setpoint. Associated with each setpoint is an SPDT alarm relay for external use. Requires an external "window-type" current transformer (supplied and installed by customer).

- Integrated into the drive's safe-stop circuit
- IEC 60755 Type B device monitors, pulsed DC, and pure DC ground fault currents
- LED bar graph indicator of the ground fault current level from 10-100% of the setpoint
- Fault memory
- TEST / RESET key

Safe Torque Off with Pilz Safety Relay

Available for drives with enclosure size F. Enables the Pilz Relay to fit in the enclosure without requiring an options cabinet. The relay is used in the external temperature monitoring option. If PTC monitoring is required, VLT® PTC Thermistor Card MCB 112 must be ordered.

Emergency Stop with Pilz Safety Relay

Includes a redundant 4-wire emergency stop pushbutton mounted on the front of the enclosure, and a Pilz relay that monitors it in conjunction with the drive's safe-stop circuit and contactor position. Requires a contactor and the options cabinet for drives with enclosure size F.

Brake Chopper (IGBTs)

Brake terminals with an IGBT brake chopper circuit allow for the connection of external brake resistors. For detailed data on brake resistors please see the VLT® Brake Resistor MCE 101 Design Guide, MG.90.Ox.yy, available at <http://drivesliterature.danfoss.com/>

Regeneration terminals

Allow connection of regeneration units to the DC bus on the capacitor bank side of the DC-link reactors for regenerative braking. The enclosure size F regeneration terminals are sized for approximately 50% the power rating of the drive. Consult the factory for regeneration power limits based on the specific drive size and voltage.

Load sharing terminals

These terminals connect to the DC-bus on the rectifier side of the DC-link reactor and allow for the sharing of DC bus power between multiple drives. For drives with enclosure size F, the load sharing terminals are sized for approximately 33% of the power rating of the drive. Consult the factory for load sharing limits based on the specific drive size and voltage.

Disconnect

A door-mounted handle disconnect switch allows for the manual operation of a power disconnect switch to enable and disable power to the drive, increasing safety during servicing. The disconnect is interlocked with the cabinet doors to prevent them from being opened while power is still applied.

Circuit breakers

A circuit breaker can be remotely tripped, but must be manually reset. Circuit breakers are interlocked with the cabinet doors to prevent them from being opened while power is still applied. When a circuit breaker is ordered as an option, fuses are also included for fast-acting current overload protection of the AC drive.

Contactors

An electrically – controlled contactor switch allows for the remote enabling and disabling of power to the drive. An auxiliary contact on the contactor is monitored by the Pilz Safety if the IEC Emergency Stop option is ordered.

Manual motor starters

Provide 3-phase power for electric cooling blowers that are often required for larger motors. Power for the starters is provided from the load side of any supplied contactor, circuit breaker or disconnect switch. If a Class 1 RFI filter option is ordered, the input side of the RFI provides the power to the starter. Power is fused before each motor starter and is off when the incoming power to the drive is off. Up to two starters are allowed. If a 30 A, fuse-protected circuit is ordered, then only one starter is allowed. Starters are integrated into the drive's safe-stop circuit.

Unit features include:

- Operation switch (on/off)
- Short circuit and overload protection with test function
- Manual reset function

30 A, fuse-protected terminals

- 3-phase power matching incoming mains voltage for powering auxiliary customer equipment
- Not available if two manual motor starters are selected
- Terminals are off when the incoming power to the drive is off
- Power for the fused-protected terminals will be provided from the load side of any supplied contactor, circuit breaker, or disconnect switch. If a Class 1 RFI filter option is ordered, the input side of the RFI provides the power to the starter.

Common Motor Terminals

The common motor terminal option provides the bus bars and hardware required to connect the motor terminals from the paralleled inverters to a single terminal (per phase) to accommodate the installation of the motor-side top entry kit.

This option is also recommended to connect the output of a drive to an output filter or output contactor. The common motor terminals eliminate the need for equal cable lengths from each inverter to the common point of the output filter (or motor).

24 V DC supply

- 5 A, 120 W, 24 V DC
- Protected against output overcurrent, overload, short circuits, and overtemperature
- For powering customer-supplied accessory devices such as sensors, PLC I/O, contactors, temperature probes, indicator lights and/or other electronic hardware
- Diagnostics include a dry DC-ok contact, a green DC-ok LED and a red overload LED

External temperature monitoring

Designed for monitoring temperatures of external system components, such as the motor windings and/or bearings. Includes eight universal input modules plus two dedicated thermistor input modules. All ten modules are integrated into the drive's safe-stop circuit and can be monitored via a fieldbus network, which requires the purchase of a separate module/bus coupler. A Safe Torque Off brake option must be ordered when selecting external temperature monitoring.

Universal inputs (5)

Signal types:

- RTD inputs (including Pt100), 3-wire or 4-wire
- Thermocouple
- Analog current or analog voltage

Additional features:

- One universal output, configurable for analog voltage or analog current
- Two output relays (N.O.)
- Dual-line LC display and LED diagnostics
- Sensor lead wire break, short circuit and incorrect polarity detection
- Interface set-up software
- If 3 PTC are required, MCB 112 control card option must be added.

Additional external temperature monitors:

- This option is available in case you need more than the MCB 114 and MCB 112 provides.

VLT® Control Panel LCP 101 (Numeric)

- Status messages
- Quick menu for easy commissioning
- Parameter setting and adjusting
- Hand-operated start/stop function or selection of Automatic mode
- Reset function

Ordering number
130B1124

VLT® Control Panel LCP 102 (Graphical)

- Multi-language display
- Quick menu for easy commissioning
- Full parameter back-up and copy function
- Alarm logging
- Info key explains the function of the selected item on display
- Hand-operated start/stop or selection of Automatic mode
- Reset function
- Trend graphing

Ordering number
130B1107

Loose kits for enclosure sizes D, E and F

Kit	Available for following enclosure sizes
NEMA 3R outdoor weather shield	D1h, D2h
USB in the door kit	D1h, D2h, D3h, D4h, D5h, D6h, D7h, D8h, E1h, E2h, F
Enclosure size F top entry kit motor cables	F
Enclosure size F top entry kit mains cables	F
Common motor terminal kits	F1/F3, F2/F4
Adapter plate	D1h, D2h, D3h, D4h
Back-channel duct kit	D1h, D2h, D3h, D4h
NEMA 3R Rittal and welded enclosures	D3h, D4h
Back-channel cooling kits for non-Rittal enclosures	D3h, D4h
Back-channel cooling kit (in-bottom/out-top)	D1h, D2h, D3h, D4h, E3h, E4h
Back-channel cooling kit (in-back/out-back)	D1h, D2h, D3h, D4h, E3h, E4h, F
Pedestal kit with in-back/out-back cooling	D1h, D2h
Pedestal kit	D1h, D2h, D5h, D6h, D7h, D8h
Top entry of fieldbus cables	D3, D4, D1h-D8h
LCP Remote Mounting Kit	Available for the full product range

NEMA 3R outdoor weather shield

Designed to be mounted over the VLT® drive to protect from direct sun, snow and falling debris. Drives used with this shield must be ordered from the factory as "NEMA 3R Ready". This is an enclosure option in the type code – E5S.

Ordering number

D1h..... 176F6302
D2h..... 176F6303

USB in the door kit

Available for all enclosure sizes, this USB extension cord kit allows access to the drive controls via laptop computer without opening the drive.

The kits can only be applied to drives manufactured after a certain date. Drives built prior to these dates do not have the provisions to accommodate the kits. Reference the following table to determine which drives the kits can be applied to.

IP20

D1h, D2h, D3h, D4h, D5h, D6h, D7h and D8h.

IP21/IP54

D1h, D2h, D3h, D4h, D5h, D6h, D7h, D8h and F.

Enclosure size F top entry kit motor cables

To use this kit, the drive must be ordered with the common motor terminal option. The kit includes everything to install a top entry cabinet on the motor side (right side) of an F size enclosure.

Ordering number

F1/F3, 400 mm 176F1838
F1/F3, 600 mm 176F1839
F2/F4 400 mm 176F1840
F2/F4, 600 mm 176F1841
F8, F9, F10, F11, F12, F13 Contact factory

Enclosure size F top entry kit mains cables

The kits include everything required to install a top entry section onto the mains side (left side) of an F size enclosure.

Ordering number

F1/F2, 400 mm	176F1832
F1/F2, 600 mm	176F1833
F3/F4 with disconnect, 400 mm	176F1834
F3/F4 with disconnect, 600 mm	176F1835
F3/F4 without disconnect, 400 mm	176F1836
F3/F4 without disconnect, 600 mm	176F1837
F8, F9, F10, F11, F12, F13	Contact factory

Common motor terminal kits

The common motor terminal kits provide the bus bars and hardware required to connect the motor terminals from the paralleled inverters to a single terminal (per phase) to accommodate the installation of the motor-side top entry kit. This kit is equivalent to the common motor terminal option of a drive. This kit is not required to install the motor-side top entry kit if the common motor terminal option was specified when the drive was ordered.

This kit is also recommended to connect the output of a drive to an output filter or output contactor. The common motor terminals eliminate the need for equal cable lengths from each inverter to the common point of the output filter (or motor).

Ordering number

F1/F2, 400 mm	176F1832
F1/F2, 600 mm	176F1833

Adapter plate

The adapter plate is used to replace an old enclosure size D drive with the new enclosure size D drive, using the same mounting.

Ordering number

D1h/D3h adapter plate to replace D1/D3 drive.....	176F3409
D2h/D4h adapter plate to replace D2/D4 drive.....	176F3410

Back-channel duct kit

Back-channel duct kits are offered for conversion of enclosure sizes D and E. They are offered in two configurations – in-bottom/out-top venting and top only venting. Available for enclosure sizes D3h and D4h.

Ordering number top and bottom

D3h kit 1800 mm	176F3627
D4h kit 1800 mm.....	176F3628
D3h Kit 2000 mm.....	176F3629
D4h Kit 2000 mm.....	176F3630

NEMA 3R Rittal and welded enclosures

The kits are designed to be used with the IP00/IP20/Chassis drives to achieve an ingress protection rating of NEMA 3R or NEMA 4. These enclosures are intended for outdoor use to provide a degree of protection against inclement weather.

Ordering number for NEMA 3R (welded enclosures)

D3h back-channel cooling kit (in back out back).....	176F3521
D4h back-channel cooling kit (in back out back).....	176F3526

Ordering number for NEMA 3R (Rittal enclosures)

D3h back-channel cooling kit (in back out back).....	176F3633
D4h Back-channel cooling kit (in back out back).....	176F3634

Back-channel cooling kits for non-Rittal enclosures

The kits are designed to be used with the IP20/Chassis drives in non-Rittal enclosures for in-back/out-back cooling. Kits do not include plates for mounting in the enclosures.

Ordering number

D3h	176F3519
D4h	176F3524

Ordering number for corrosion resistant

D3h	176F3520
D4h.....	176F3525

Back-channel cooling kit (in-bottom/out-back)

Kit for directing the back-channel air flow in the bottom of the drive and out the back.

Ordering number

D1h/D3h.....	176F3522
D2h/D4h	176F3527

Ordering number corrosion resistant

D1h/D3h.....	176F3523
D2h/D4h	176F3528

Back-channel cooling kit (in-back/out-back)

These kits are designed to be used for redirecting the back-channel air flow. Factory back-channel cooling directs air in the bottom of the drive and out the top. The kit allows the air to be directed in and out the back of the drive.

Ordering number for in-back/out-back cooling kit

D1h.....	176F3648
D2h.....	176F3649
D3h	176F3625
D4h.....	176F3626
D5h/D6h	176F3530
D7h/D8h	176F3531

Ordering number for corrosion resistant

D1h.....	176F3656
D2h.....	176F3657
D3h.....	176F3654
D4h.....	176F3655

Ordering number for VLT® Low Harmonic Drives

D1n.....	176F6482
D2n.....	176F6481
E9	176F3538
F18.....	176F3534

Ordering number for VLT® Advanced Active Filter AAF 006

D14.....	176F3535
----------	----------

Pedestal kit with in-back/out-back cooling

See additional documents 177R0508 and 177R0509.

Ordering number

D1h 400 mm kit	176F3532
D2h 400 mm kit.....	176F3533

Pedestal kit

The pedestal kit is a 400 mm high pedestal for enclosure sizes D1h and D2h, and 200 mm high for enclosure sizes D5h and D6h, that allows the drives to be floor mounted. The front of the pedestal has openings for input air to cool the power components.

Ordering number

D1h 400 mm kit	176F3631
D2h 400 mm kit.....	176F3632
D5h/D6h 200 mm kit.....	176F3452
D7h/D8h 200 mm kit.....	176F3539

Input-plate option kit

Input-plate option kits are available for enclosure sizes D and E. The kits can be ordered to add fuses, disconnect/fuses, RFI, RFI/fuses and RFI/disconnect/fuses. Please consult the factory for kit ordering numbers.

Top entry of fieldbus cables

The top entry kit provides the ability to install fieldbus cables through the top of the drive. The kit is IP20 when installed. If an increased rating is desired, a different mating connector can be used.

Ordering number

D3/D4.....	176F1742
D1h-D8h.....	176F3594

LCP Remote Mounting Kit

The kit makes it possible to detach the LCP from the drive, so it can for example be mounted outside an air handling unit (AHU) for easy operation.

The LCP Remote Mounting Kit offers an easy-to-install, IP54 design which you can mount on panels and walls of 1-90 mm thickness. The front cover blocks the sunlight for convenient programming. The closed cover is lockable to prevent tampering, while keeping the On/Warning/Alarm LEDs visible. The kit is available with 3 m, 5 m or 10 m cable. It is compatible with all VLT® Local Control Panel options.

Ordering number for IP20 enclosure

3 m cable length.....	134B5223
5 m cable length.....	134B5224
10 m cable length.....	134B5225



Minimize energy usage while maximizing comfort levels with VLT[®] HVAC Drive

The VLT[®] HVAC Drive is installed on a daily basis in various heating, ventilation and air conditioning and water-boosting applications in new and existing buildings and infrastructural systems all over the world.

VLT[®] drives enhance air quality and indoor comfort levels, improve control and energy-saving possibilities, ensure better asset protection, reduce maintenance costs and increase reliability.

The daily load variation in HVAC facilities is considerable. Variable speed control of electrical motors has proved to be one of the most effective cost-reducing measures available.

World's greenest hotel uses **60% less electricity**

Crowne Plaza Copenhagen Towers Hotel



See the video

70% savings in central heating

Danfoss' industrial park, Denmark



Read the story

Danfoss and Inertech **change the future** of data centre **cooling**

Inertech, North America



See the video

Discover more case stories for the HVAC industry here: <http://drives.danfoss.com/industries/hvac/case-stories/#/>

Follow us and learn more about AC drives



VLT[®] | VAGON[®]

Danfoss can accept no responsibility for possible errors in catalogues, brochures and other printed material. Danfoss reserves the right to alter its products without notice. This also applies to products already on order provided that such alterations can be made without subsequential changes being necessary in specifications already agreed. All trademarks in this material are property of the respective companies. Danfoss and the Danfoss logotype are trademarks of Danfoss A/S. All rights reserved.